

# IGBT with Monolithic Free Wheeling Diode

## NGTB30N140IHR3WG

This Insulated Gate Bipolar Transistor (IGBT) features a robust and cost effective ultra Field Stop (FS) Trench construction and provides superior performance. It is especially designed for low on-state and is well suited for resonant or soft switching topologies, such as those used in inductive heating applications. The device contains a reverse conducting diode integrated on the same die, which makes the device construction very cost effective.

### Features

- Extremely Efficient Trench with Ultra Field Stop Technology
- 1400 V Breakdown Voltage
- Optimized for Low Losses in IH Cooker Application
- Reliable and Cost Effective Single Die Solution
- These are Pb-Free Devices

### Typical Applications

- Inductive Heating
- Consumer Appliances
- Soft Switching

### ABSOLUTE MAXIMUM RATINGS

| Rating   | Symbol    | Value                | Unit             |
|--|-----------|----------------------|------------------|
| Collector-emitter voltage @<br>$T_J = 25^\circ\text{C}$  | $V_{CES}$ | 1400                 | V                |
| Collector current<br>@ $T_C = 25^\circ\text{C}$<br>@ $T_C = 100^\circ\text{C}$                                   | $I_C$     | 60<br>30             | A                |
| Pulsed collector current, $T_{pulse}$<br>limited by $T_{Jmax}$ 10 $\mu\text{s}$ pulse,<br>$V_{GE} = 15\text{ V}$ | $I_{CM}$  | 120                  | A                |
| Diode forward current<br>@ $T_C = 25^\circ\text{C}$<br>@ $T_C = 100^\circ\text{C}$                               | $I_F$     | 60<br>30             | A                |
| Diode pulsed current, $T_{pulse}$ limited<br>by $T_{Jmax}$ 10 $\mu\text{s}$ pulse, $V_{GE} = 0\text{ V}$         | $I_{FM}$  | 120                  | A                |
| Gate-emitter voltage<br>Transient Gate-emitter Voltage<br>( $T_{pulse} = 5\ \mu\text{s}$ , $D < 0.10$ )          | $V_{GE}$  | $\pm 20$<br>$\pm 25$ | V                |
| Power Dissipation<br>@ $T_C = 25^\circ\text{C}$<br>@ $T_C = 100^\circ\text{C}$                                   | $P_D$     | 357<br>178           | W                |
| Operating junction temperature range   | $T_J$     | -40 to +175          | $^\circ\text{C}$ |
| Storage temperature range  | $T_{stg}$ | -55 to +175          | $^\circ\text{C}$ |
| Lead temperature for soldering, 1/8"<br>from case for 5 seconds  | $T_{SLD}$ | 260                  | $^\circ\text{C}$ |

Stresses exceeding those listed in the Maximum Ratings table may damage the device. If any of these limits are exceeded, device functionality should not be assumed, damage may occur and reliability may be affected.



ON Semiconductor®

[www.onsemi.com](http://www.onsemi.com)

30 A, 1400 V  
 $V_{CESat} = 1.8\text{ V}$   
 $E_{off} = 1.05\text{ mJ}$

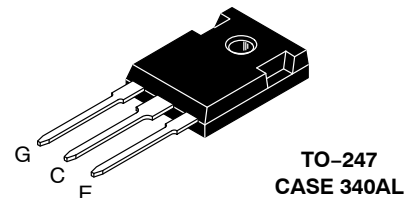
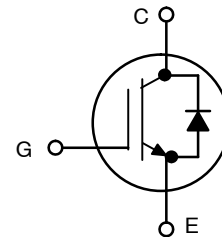

### MARKING DIAGRAM



A = Assembly Location  
Y = Year  
WW = Work Week  
G = Pb-Free Package

### ORDERING INFORMATION

| Device           | Package             | Shipping        |
|------------------|---------------------|-----------------|
| NGTB30N140IHR3WG | TO-247<br>(Pb-Free) | 30 Units / Rail |

# NGTB30N140IHR3WG

## THERMAL CHARACTERISTICS

| Rating                                 | Symbol          | Value | Unit                        |
|--|-----------------|-------|-----------------------------|
| Thermal resistance junction-to-case    | $R_{\theta JC}$ | 0.42  | $^{\circ}\text{C}/\text{W}$ |
| Thermal resistance junction-to-ambient | $R_{\theta JA}$ | 40    | $^{\circ}\text{C}/\text{W}$ |

## ELECTRICAL CHARACTERISTICS ( $T_J = 25^{\circ}\text{C}$ unless otherwise specified)

| Parameter | Test Conditions | Symbol | Min | Typ | Max | Unit |
|-----------|-----------------|--------|-----|-----|-----|------|
|-----------|-----------------|--------|-----|-----|-----|------|

### STATIC CHARACTERISTIC

|   |   |               |      |              |            |               |
|---|---|---------------|------|--------------|------------|---------------|
| Collector-emitter breakdown voltage, gate-emitter short-circuited | $V_{GE} = 0\text{ V}, I_C = 1\text{ mA}$  | $V_{(BR)CES}$ | 1400 | -            | -          | V             |
| Collector-emitter saturation voltage                              | $V_{GE} = 15\text{ V}, I_C = 30\text{ A}$<br>$V_{GE} = 15\text{ V}, I_C = 30\text{ A}, T_J = 175^{\circ}\text{C}$         | $V_{CEsat}$   | -    | 1.80<br>2.43 | 1.95<br>-  | V             |
| Gate-emitter threshold voltage                                    | $V_{GE} = V_{CE}, I_C = 175\text{ }\mu\text{A}$   | $V_{GE(th)}$  | 4.5  | 5.7          | 6.5        | V             |
| Collector-emitter cut-off current, gate-emitter short-circuited   | $V_{GE} = 0\text{ V}, V_{CE} = 1400\text{ V}$<br>$V_{GE} = 0\text{ V}, V_{CE} = 1400\text{ V}, T_J = 175^{\circ}\text{C}$ | $I_{CES}$     | -    | -            | 20<br>1000 | $\mu\text{A}$ |
| Gate leakage current, collector-emitter short-circuited           | $V_{GE} = 20\text{ V}, V_{CE} = 0\text{ V}$   | $I_{GES}$     | -    | -            | 120        | nA            |

### DYNAMIC CHARACTERISTIC

|                              |  |           |   |      |   |    |
|------------------------------|--|-----------|---|------|---|----|
| Input capacitance            | $V_{CE} = 20\text{ V}, V_{GE} = 0\text{ V}, f = 1\text{ MHz}$    | $C_{ies}$ | - | 3505 | - | pF |
| Output capacitance           |  | $C_{oes}$ | - | 70   | - |    |
| Reverse transfer capacitance |  | $C_{res}$ | - | 58   | - |    |
| Gate charge total            | $V_{CE} = 600\text{ V}, I_C = 30\text{ A}, V_{GE} = 15\text{ V}$ | $Q_g$     | - | 163  | - | nC |
| Gate to emitter charge       |  | $Q_{ge}$  | - | 30   | - |    |
| Gate to collector charge     |  | $Q_{gc}$  | - | 81   | - |    |

### SWITCHING CHARACTERISTIC, INDUCTIVE LOAD

|                         |  |              |   |      |   |    |
|-------------------------|--|--------------|---|------|---|----|
| Turn-off delay time     | $T_J = 25^{\circ}\text{C}, V_{CC} = 600\text{ V},$<br>$I_C = 30\text{ A}, R_g = 10\text{ }\Omega$<br>$V_{GE} = -1.5\text{ V to } +15\text{ V}$ | $t_{d(off)}$ | - | 197  | - | ns |
| Fall time               |  | $t_f$        | - | 122  | - |    |
| Turn-off switching loss |  | $E_{off}$    | - | 1.05 | - |    |
| Turn-off delay time     | $T_J = 150^{\circ}\text{C}, V_{CC} = 600\text{ V},$<br>$I_C = 30\text{ A}, R_g = 10\text{ }\Omega$<br>$V_{GE} = 15\text{ V}$                   | $t_{d(off)}$ | - | 209  | - | ns |
| Fall time               |  | $t_f$        | - | 214  | - |    |
| Turn-off switching loss |  | $E_{off}$    | - | 1.75 | - |    |

### DIODE CHARACTERISTIC

|                 |   |       |   |              |           |   |
|-----------------|---|-------|---|--------------|-----------|---|
| Forward voltage | $V_{GE} = 0\text{ V}, I_F = 30\text{ A}$<br>$V_{GE} = 0\text{ V}, I_F = 30\text{ A}, T_J = 175^{\circ}\text{C}$ | $V_F$ | - | 1.90<br>2.48 | 2.10<br>- | V |
|-----------------|---|-------|---|--------------|-----------|---|

Product parametric performance is indicated in the Electrical Characteristics for the listed test conditions, unless otherwise noted. Product performance may not be indicated by the Electrical Characteristics if operated under different conditions.

# NGTB30N140IHR3WG

## TYPICAL CHARACTERISTICS

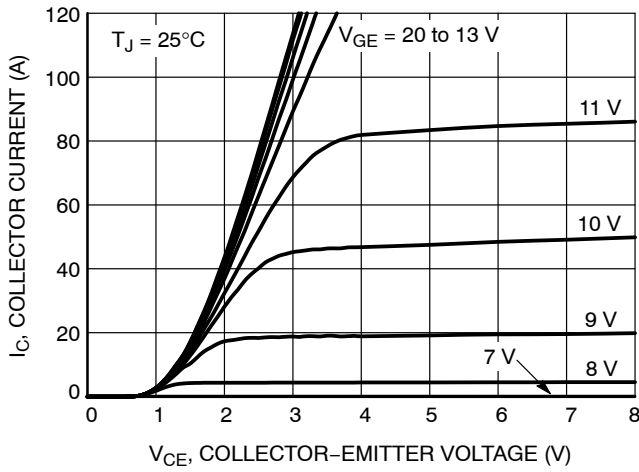

Figure 1. Output Characteristics

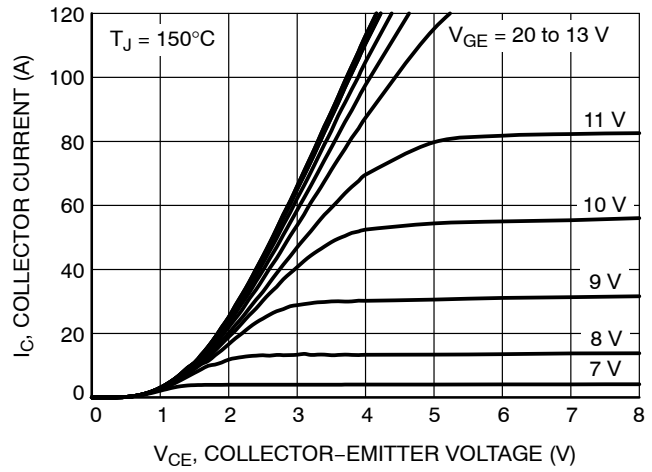

Figure 2. Output Characteristics

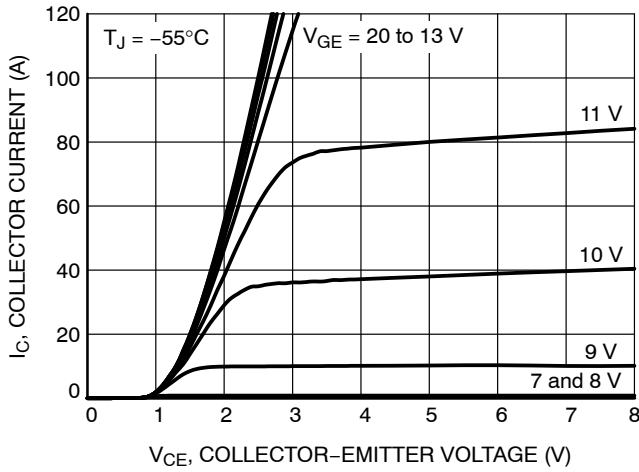

Figure 3. Output Characteristics

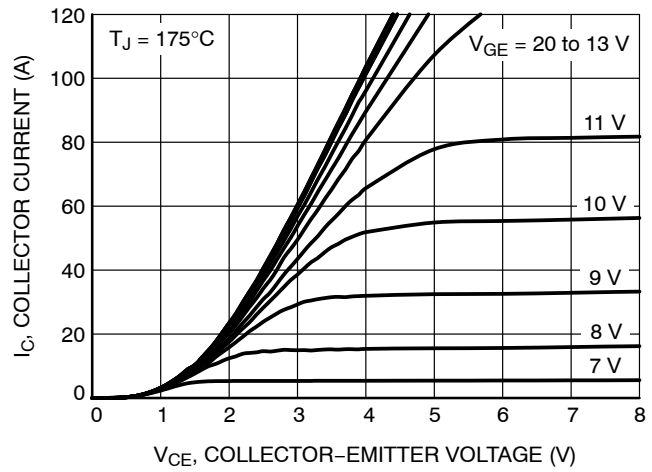

Figure 4. Output Characteristics

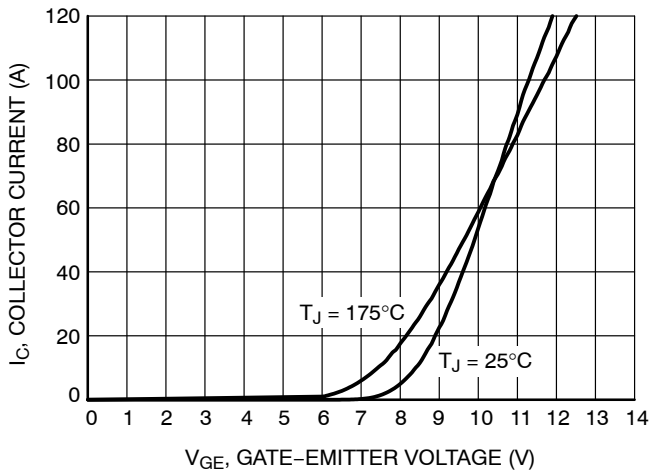

Figure 5. Typical Transfer Characteristics

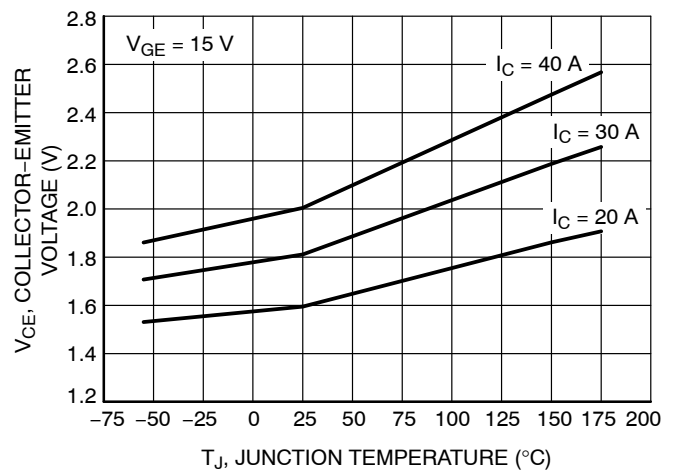

Figure 6.  $V_{CE(sat)}$  vs.  $T_J$

# NGTB30N140IHR3WG

## TYPICAL CHARACTERISTICS

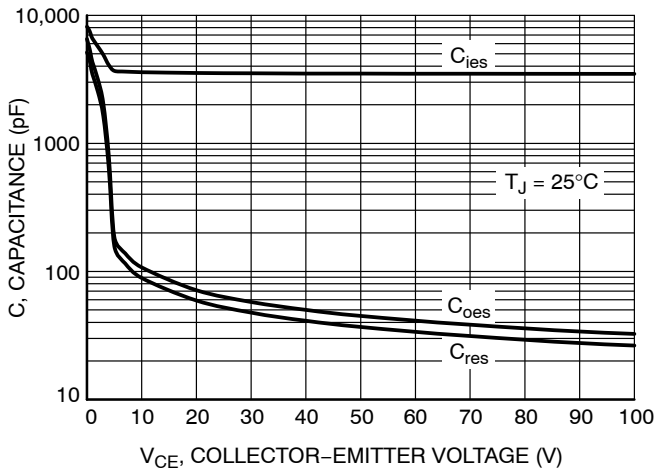

Figure 7. Typical Capacitance

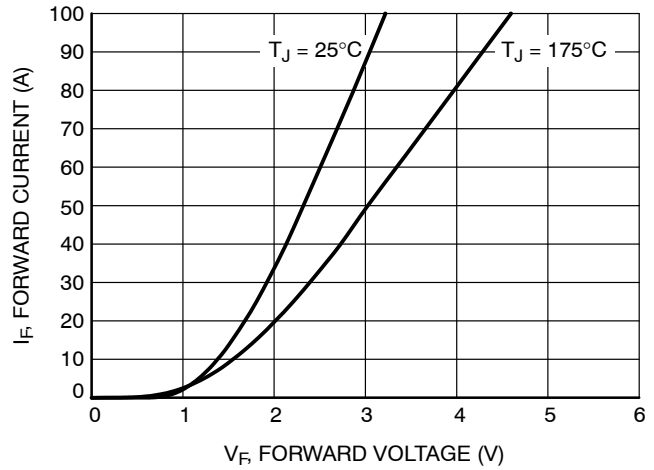

Figure 8. Diode Forward Characteristics

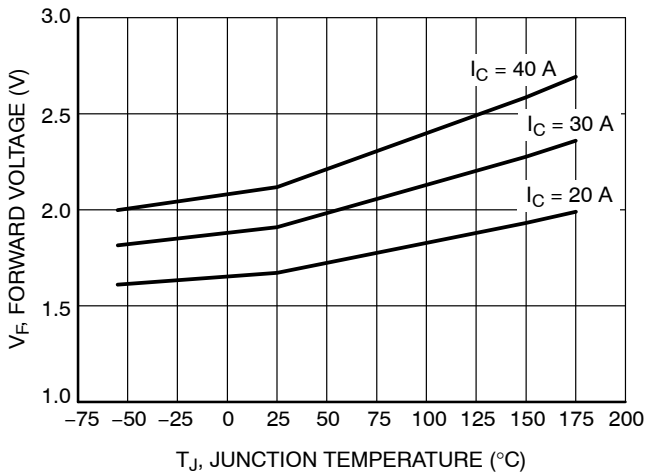

Figure 9.  $V_F$  vs.  $T_J$

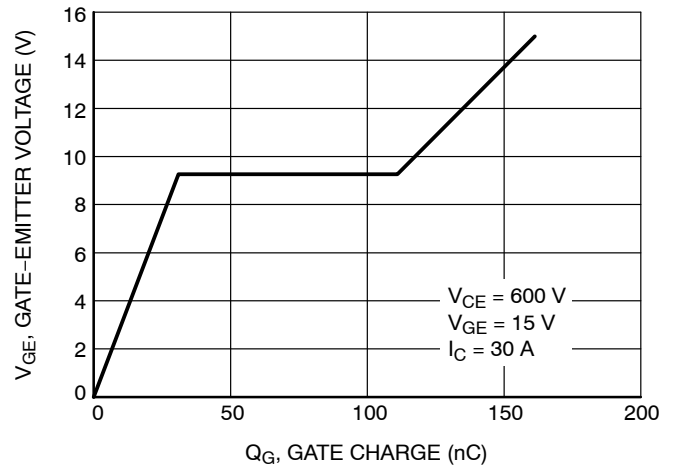

Figure 10. Typical Gate Charge

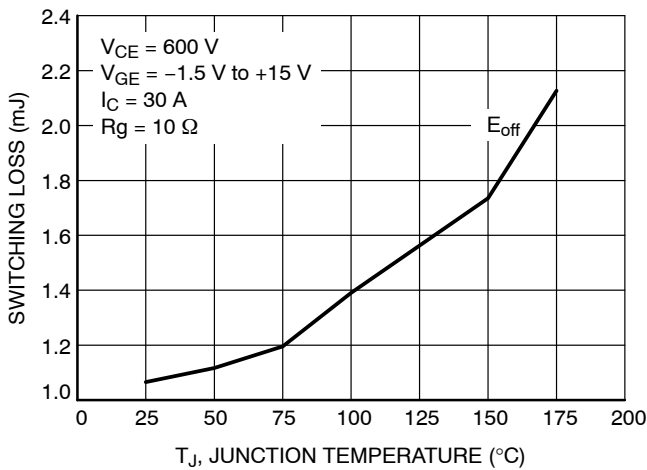

Figure 11. Switching Loss vs. Temperature

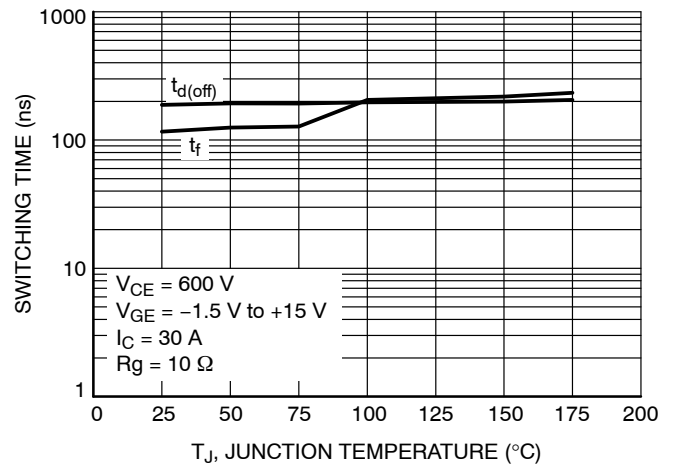

Figure 12. Switching Loss vs. Temperature

# NGTB30N140IHR3WG

## TYPICAL CHARACTERISTICS

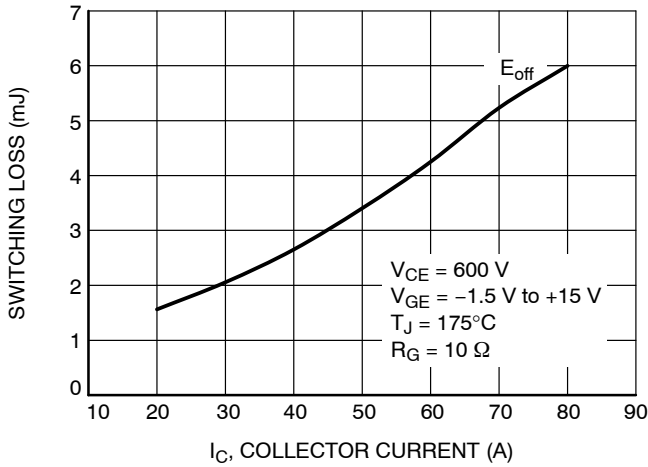

Figure 13. Switching Loss vs.  $I_C$

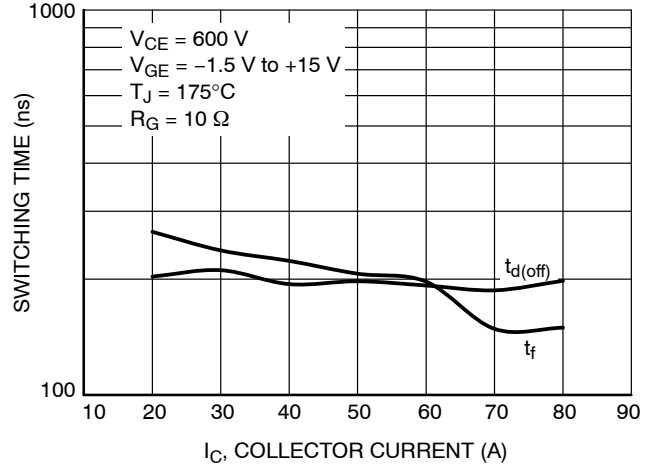

Figure 14. Switching Time vs.  $I_C$

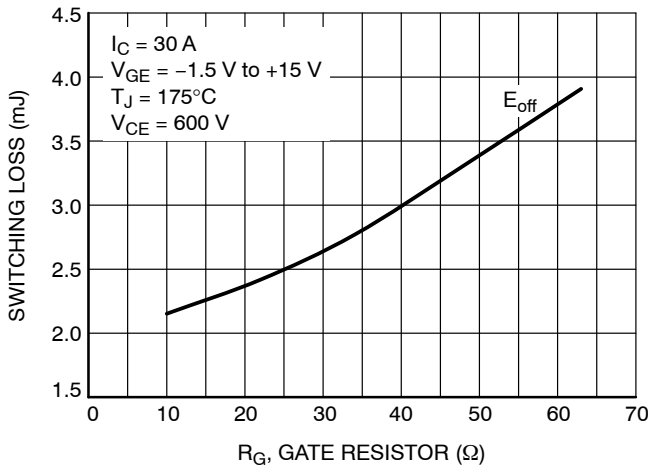

Figure 15. Switching Loss vs. Gate Resistor

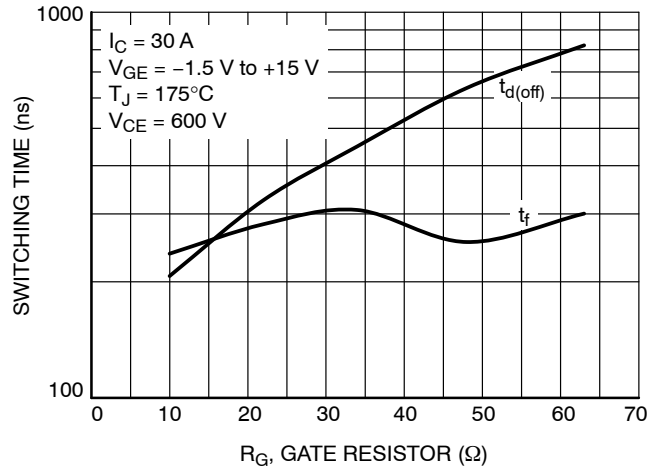

Figure 16. Switching Time vs. Gate Resistor

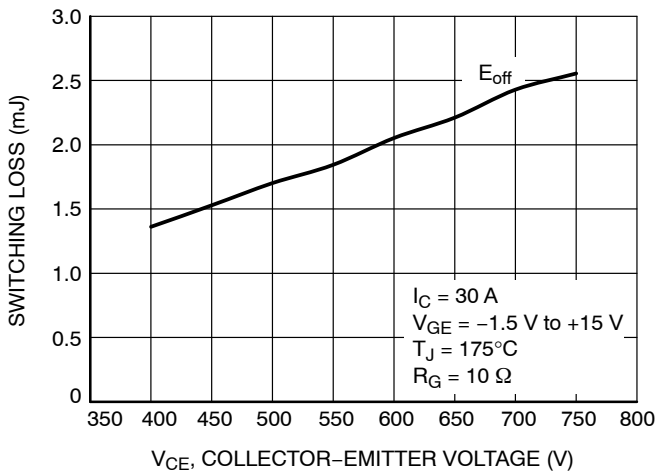

Figure 17. Switching Loss vs.  $V_{CE}$

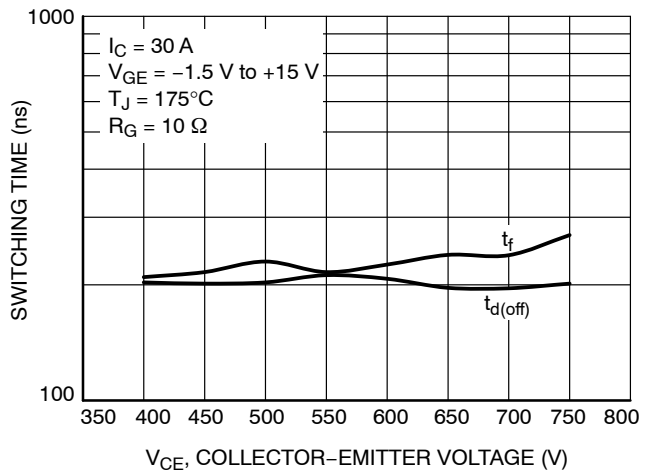

Figure 18. Switching Time vs.  $V_{CE}$

# NGTB30N140IHR3WG

## TYPICAL CHARACTERISTICS

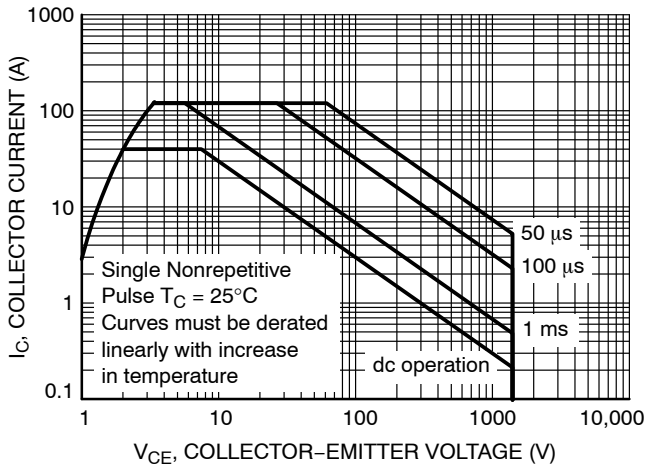

Figure 19. Safe Operating Area

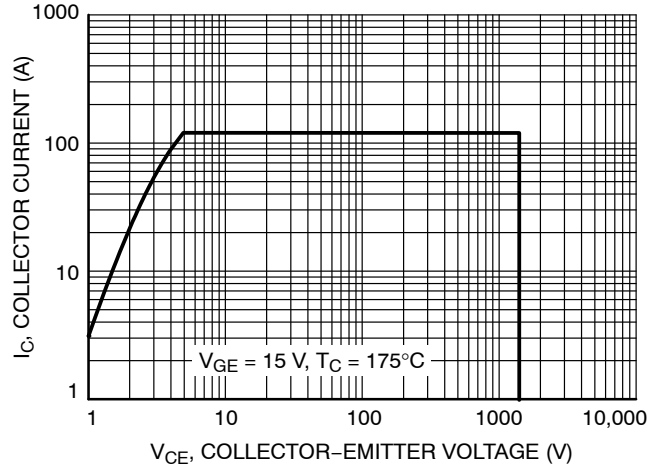

Figure 20. Reverse Bias Safe Operating Area

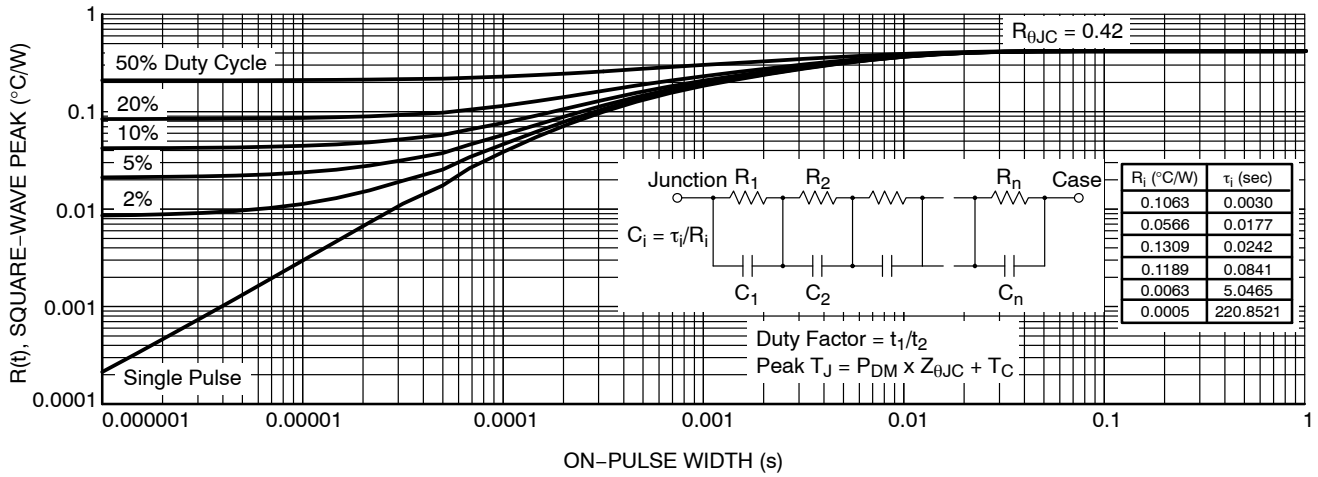

Figure 21. IGBT Transient Thermal Impedance

NGTB30N140IHR3WG

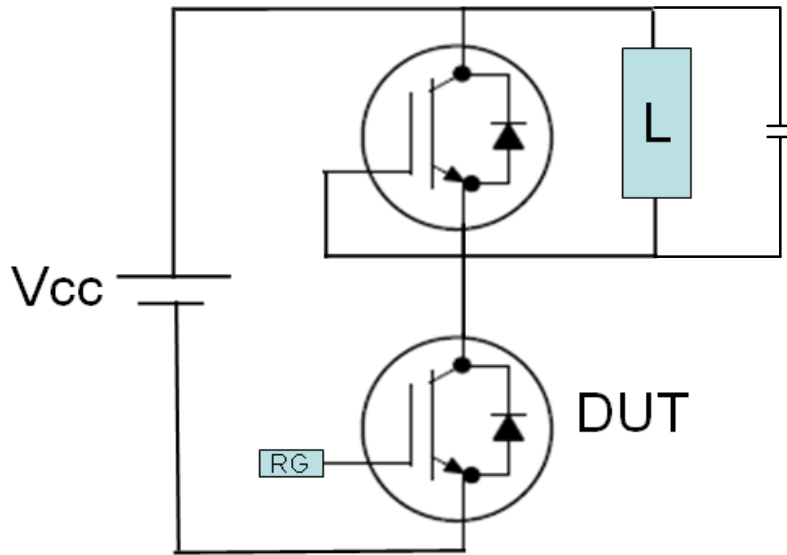

Figure 22. Test Circuit for Switching Characteristics

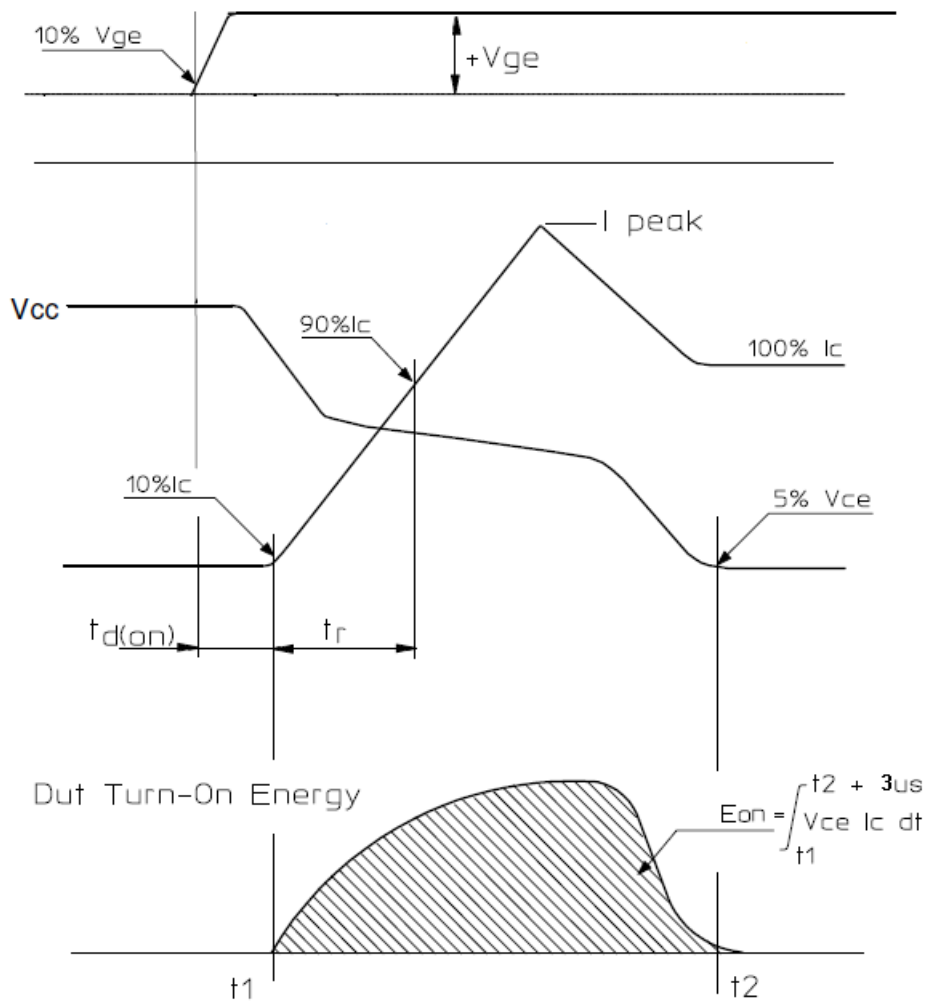

Figure 23. Definition of Turn On Waveform

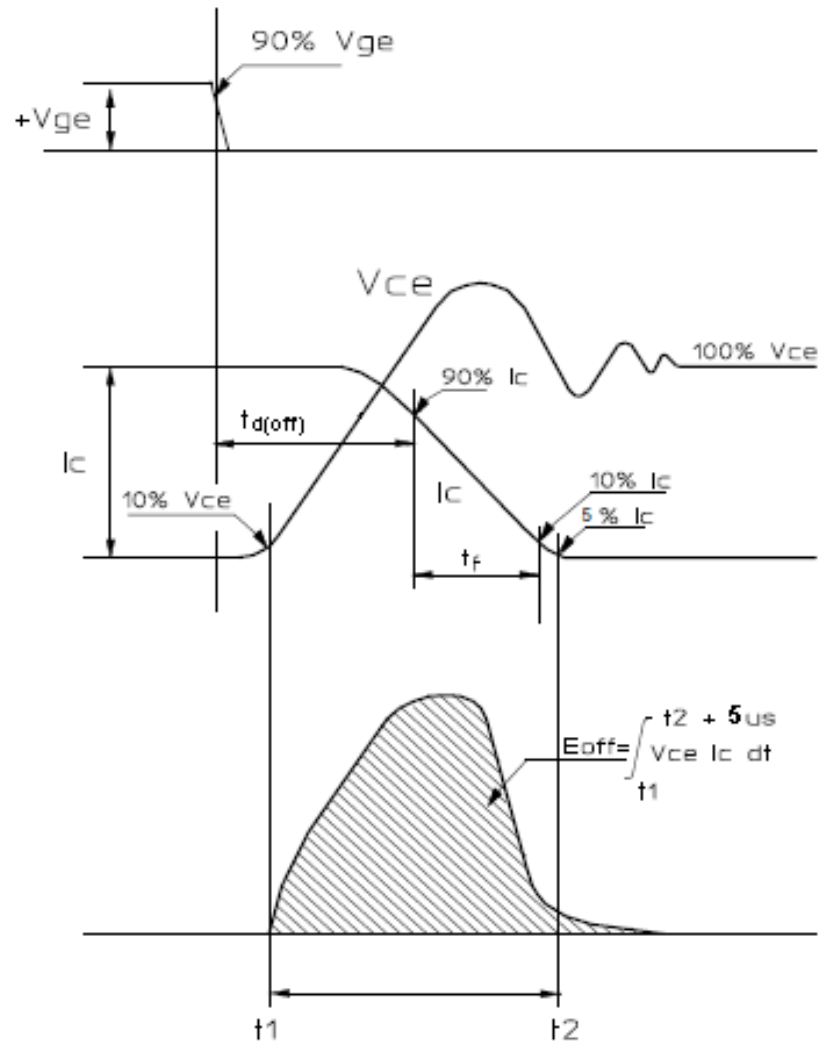
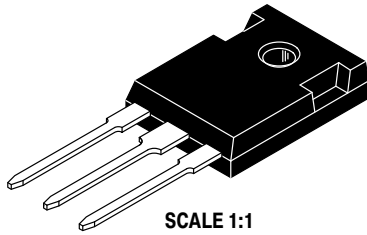

Figure 24. Definition of Turn Off Waveform



TO-247  
CASE 340AL  
ISSUE D

DATE 17 MAR 2017



SCALE 1:1

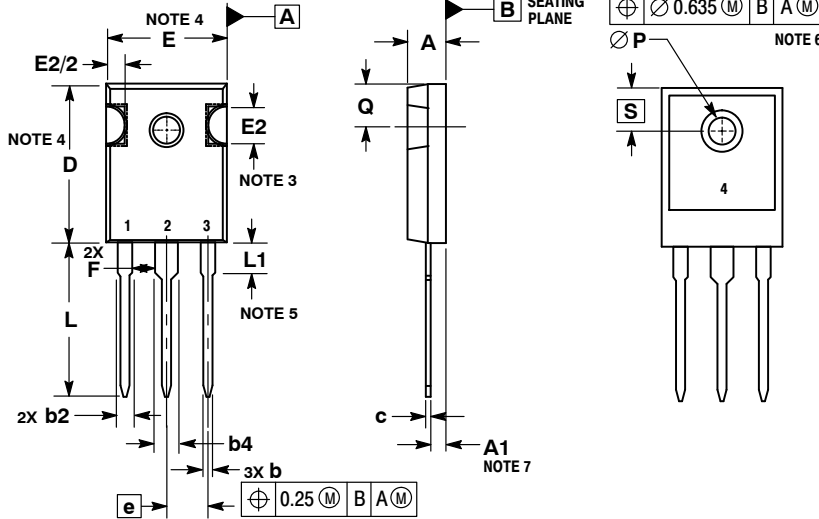

NOTES:

1. DIMENSIONING AND TOLERANCING PER ASME Y14.5M, 1994.
2. CONTROLLING DIMENSION: MILLIMETERS.
3. SLOT REQUIRED, NOTCH MAY BE ROUNDED.
4. DIMENSIONS D AND E DO NOT INCLUDE MOLD FLASH. MOLD FLASH SHALL NOT EXCEED 0.13 PER SIDE. THESE DIMENSIONS ARE MEASURED AT THE OUTERMOST EXTREME OF THE PLASTIC BODY.
5. LEAD FINISH IS UNCONTROLLED IN THE REGION DEFINED BY L1.
6.  $\varnothing P$  SHALL HAVE A MAXIMUM DRAFT ANGLE OF 1.5° TO THE TOP OF THE PART WITH A MAXIMUM DIAMETER OF 3.91.
7. DIMENSION A1 TO BE MEASURED IN THE REGION DEFINED BY L1.

| MILLIMETERS |          |       |
|-------------|----------|-------|
| DIM         | MIN      | MAX   |
| A           | 4.70     | 5.30  |
| A1          | 2.20     | 2.60  |
| b           | 1.07     | 1.33  |
| b2          | 1.65     | 2.35  |
| b4          | 2.60     | 3.40  |
| c           | 0.45     | 0.68  |
| D           | 20.80    | 21.34 |
| E           | 15.50    | 16.25 |
| E2          | 4.32     | 5.49  |
| e           | 5.45 BSC |       |
| F           | 2.655    | ---   |
| L           | 19.80    | 20.80 |
| L1          | 3.81     | 4.32  |
| P           | 3.55     | 3.65  |
| Q           | 5.40     | 6.20  |
| S           | 6.15 BSC |       |

GENERIC  
MARKING DIAGRAM\*

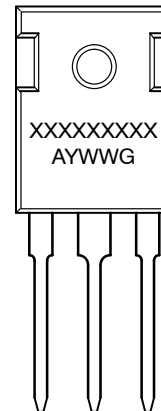

- XXXXX = Specific Device Code
- A = Assembly Location
- Y = Year
- WW = Work Week
- G = Pb-Free Package

\*This information is generic. Please refer to device data sheet for actual part marking.  
Pb-Free indicator, "G" or microdot "▪", may or may not be present.

|                  |             |   |
|------------------|-------------|---|
| DOCUMENT NUMBER: | 98AON16119F | Electronic versions are uncontrolled except when accessed directly from the Document Repository.<br>Printed versions are uncontrolled except when stamped "CONTROLLED COPY" in red. |
| DESCRIPTION:     | TO-247      | PAGE 1 OF 1   |

onsemi and ONSEMI are trademarks of Semiconductor Components Industries, LLC dba onsemi or its subsidiaries in the United States and/or other countries. onsemi reserves the right to make changes without further notice to any products herein. onsemi makes no warranty, representation or guarantee regarding the suitability of its products for any particular purpose, nor does onsemi assume any liability arising out of the application or use of any product or circuit, and specifically disclaims any and all liability, including without limitation special, consequential or incidental damages. onsemi does not convey any license under its patent rights nor the rights of others.

**onsemi**, **Onsemi**, and other names, marks, and brands are registered and/or common law trademarks of Semiconductor Components Industries, LLC dba "**onsemi**" or its affiliates and/or subsidiaries in the United States and/or other countries. **onsemi** owns the rights to a number of patents, trademarks, copyrights, trade secrets, and other intellectual property. A listing of **onsemi**'s product/patent coverage may be accessed at [www.onsemi.com/site/pdf/Patent-Marking.pdf](http://www.onsemi.com/site/pdf/Patent-Marking.pdf). **onsemi** reserves the right to make changes at any time to any products or information herein, without notice. The information herein is provided "as-is" and **onsemi** makes no warranty, representation or guarantee regarding the accuracy of the information, product features, availability, functionality, or suitability of its products for any particular purpose, nor does **onsemi** assume any liability arising out of the application or use of any product or circuit, and specifically disclaims any and all liability, including without limitation special, consequential or incidental damages. Buyer is responsible for its products and applications using **onsemi** products, including compliance with all laws, regulations and safety requirements or standards, regardless of any support or applications information provided by **onsemi**. "Typical" parameters which may be provided in **onsemi** data sheets and/or specifications can and do vary in different applications and actual performance may vary over time. All operating parameters, including "Typicals" must be validated for each customer application by customer's technical experts. **onsemi** does not convey any license under any of its intellectual property rights nor the rights of others. **onsemi** products are not designed, intended, or authorized for use as a critical component in life support systems or any FDA Class 3 medical devices or medical devices with a same or similar classification in a foreign jurisdiction or any devices intended for implantation in the human body. Should Buyer purchase or use **onsemi** products for any such unintended or unauthorized application, Buyer shall indemnify and hold **onsemi** and its officers, employees, subsidiaries, affiliates, and distributors harmless against all claims, costs, damages, and expenses, and reasonable attorney fees arising out of, directly or indirectly, any claim of personal injury or death associated with such unintended or unauthorized use, even if such claim alleges that **onsemi** was negligent regarding the design or manufacture of the part. **onsemi** is an Equal Opportunity/Affirmative Action Employer. This literature is subject to all applicable copyright laws and is not for resale in any manner.

---

## ADDITIONAL INFORMATION

### TECHNICAL PUBLICATIONS:

Technical Library: [www.onsemi.com/design/resources/technical-documentation](http://www.onsemi.com/design/resources/technical-documentation)  
onsemi Website: [www.onsemi.com](http://www.onsemi.com)

### ONLINE SUPPORT: [www.onsemi.com/support](http://www.onsemi.com/support)

For additional information, please contact your local Sales Representative at [www.onsemi.com/support/sales](http://www.onsemi.com/support/sales)