

# QORVO

## SiC JFET Division

### Is Now Part of

# onsemi™

To learn more about onsemi™, please visit our website at  
[www.onsemi.com](http://www.onsemi.com)

**onsemi** and **onsemi** and other names, marks, and brands are registered and/or common law trademarks of Semiconductor Components Industries, LLC dba "**onsemi**" or its affiliates and/or subsidiaries in the United States and/or other countries. **onsemi** owns the rights to a number of patents, trademarks, copyrights, trade secrets, and other intellectual property. A listing of **onsemi** product/patent coverage may be accessed at [www.onsemi.com/site/pdf/Patent-Marking.pdf](http://www.onsemi.com/site/pdf/Patent-Marking.pdf). **onsemi** reserves the right to make changes at any time to any products or information herein, without notice. The information herein is provided "as-is" and **onsemi** makes no warranty, representation or guarantee regarding the accuracy of the information, product features, availability, functionality, or suitability of its products for any particular purpose, nor does **onsemi** assume any liability arising out of the application or use of any product or circuit, and specifically disclaims any and all liability, including without limitation special, consequential or incidental damages. Buyer is responsible for its products and applications using **onsemi** products, including compliance with all laws, regulations and safety requirements or standards, regardless of any support or applications information provided by **onsemi**. "Typical" parameters which may be provided in **onsemi** data sheets and/or specifications can and do vary in different applications and actual performance may vary over time. All operating parameters, including "Typicals" must be validated for each customer application by customer's technical experts. **onsemi** does not convey any license under any of its intellectual property rights nor the rights of others. **onsemi** products are not designed, intended, or authorized for use as a critical component in life support systems or any FDA Class 3 medical devices or medical devices with a same or similar classification in a foreign jurisdiction or any devices intended for implantation in the human body. Should Buyer purchase or use **onsemi** products for any such unintended or unauthorized application, Buyer shall indemnify and hold **onsemi** and its officers, employees, subsidiaries, affiliates, and distributors harmless against all claims, costs, damages, and expenses, and reasonable attorney fees arising out of, directly or indirectly, any claim of personal injury or death associated with such unintended or unauthorized use, even if such claim alleges that **onsemi** was negligent regarding the design or manufacture of the part. **onsemi** is an Equal Opportunity/Affirmative Action Employer. This literature is subject to all applicable copyright laws and is not for resale in any manner. Other names and brands may be claimed as the property of others.

DATASHEET

# UJ3D1202TS

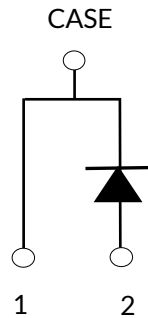
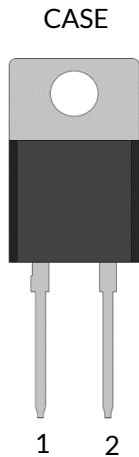

## Silicon Carbide (SiC) Diode - EliteSiC, TO-220-2L, 2 A, 1200 V SiC Merged PiN-Schottky (MPS) Diode

Rev. D, Jan 2025

### Description

UnitedSiC offers the 3<sup>rd</sup> generation of high performance SiC Merged-PiN-Schottky (MPS) diodes. With zero reverse recovery charge and 175°C maximum junction temperature, these diodes are ideally suited for high frequency and high efficiency power systems with minimum cooling requirements.

### Features

- ◆ Maximum operating temperature of 175°C
- ◆ Easy paralleling
- ◆ Extremely fast switching not dependent on temperature
- ◆ No reverse or forward recovery
- ◆ Enhanced surge current capability, MPS structure
- ◆ Excellent thermal performance, Ag sintered
- ◆ 100% UIS tested
- ◆ AEC-Q101 qualified

- ◆ Power converters
- ◆ Industrial motor drives
- ◆ Switch mode power supplies
- ◆ Power factor correction modules

Part Number	Package	Marking
UJ3D1202TS	TO-220-2L	UJ3D1202TS



## Maximum Ratings

Parameter	Symbol	Test Conditions	Value	Units
DC blocking voltage	$V_R$		1200	V
Repetitive peak reverse voltage, $T_J=25^\circ\text{C}$	$V_{RRM}$		1200	V
Surge peak reverse voltage	$V_{RSM}$		1200	V
Maximum DC forward current	$I_F$	$T_C = 164^\circ\text{C}$	2	A
Non-repetitive forward surge current sine halfwave	$I_{FSM}$	$T_C = 25^\circ\text{C}, t_p = 10\text{ms}$	30	A
		$T_C = 110^\circ\text{C}, t_p = 10\text{ms}$	27	
Repetitive forward surge current sine halfwave, $D=0.1$	$I_{FRM}$	$T_C = 25^\circ\text{C}, t_p = 10\text{ms}$	14.8	A
		$T_C = 110^\circ\text{C}, t_p = 10\text{ms}$	8.8	
Non-repetitive peak forward current	$I_{F,max}$	$T_C = 25^\circ\text{C}, t_p = 10\mu\text{s}$	250	A
		$T_C = 110^\circ\text{C}, t_p = 10\mu\text{s}$	250	
$i^2t$ value	$\int i^2 dt$	$T_C = 25^\circ\text{C}, t_p = 10\text{ms}$	4.5	$\text{A}^2\text{s}$
		$T_C = 110^\circ\text{C}, t_p = 10\text{ms}$	3.6	
Power dissipation	$P_{tot}$	$T_C = 25^\circ\text{C}$	75	W
		$T_C = 164^\circ\text{C}$	5.5	
Maximum junction temperature	$T_{J,max}$		175	$^\circ\text{C}$
Operating and storage temperature	$T_J, T_{STG}$		-55 to 175	$^\circ\text{C}$
Soldering temperatures, wavesoldering only allowed at leads	$T_{sold}$	1.6mm from case for 10s	260	$^\circ\text{C}$

## Thermal Characteristics

Parameter	Symbol	Test Conditions	Value			Units
			Min	Typ	Max	
Thermal resistance, junction-to-case	$R_{\theta JC}$			1.5	2	$^\circ\text{C}/\text{W}$

## Electrical Characteristics ( $T_J = +25^\circ\text{C}$ unless otherwise specified)

Parameter	Symbol	Test Conditions	Value			Units
			Min	Typ	Max	
Forward voltage	$V_F$	$I_F = 2\text{A}, T_J = 25^\circ\text{C}$	-	1.4	1.6	V
		$I_F = 2\text{A}, T_J = 150^\circ\text{C}$	-	1.85	2.3	
		$I_F = 2\text{A}, T_J = 175^\circ\text{C}$	-	2	2.6	
Reverse current	$I_R$	$V_R = 1200\text{V}, T_J = 25^\circ\text{C}$	-	2	22	$\mu\text{A}$
		$V_R = 1200\text{V}, T_J = 175^\circ\text{C}$	-	60		
Total capacitive charge <sup>(1)</sup>	$Q_C$	$V_R = 800\text{V}$		12		nC
Total capacitance	C	$V_R = 1\text{V}, f = 1\text{MHz}$		109		pF
		$V_R = 400\text{V}, f = 1\text{MHz}$		11.5		
		$V_R = 800\text{V}, f = 1\text{MHz}$		9.8		
Capacitance stored energy	$E_C$	$V_R = 800\text{V}$		3.6		$\mu\text{J}$

(1)  $Q_C$  is independent on  $T_J$ ,  $di_F/dt$ , and  $I_F$  as shown in the application note USCi\_AN0011.

## Typical Performance Diagrams

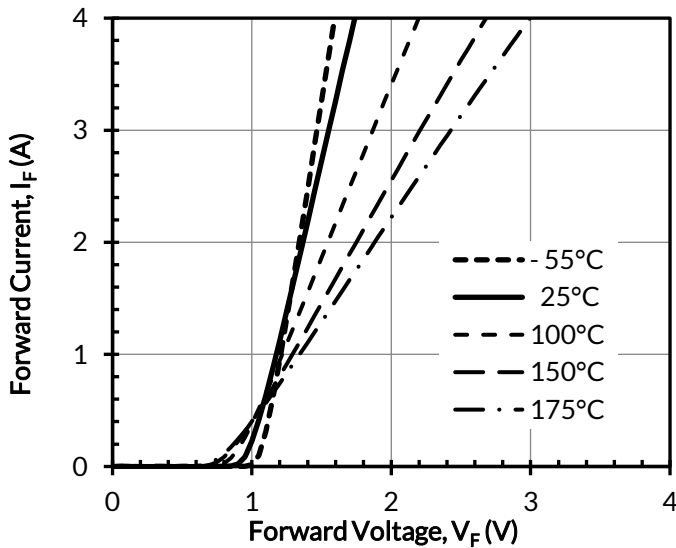

Figure 1. Typical forward characteristics

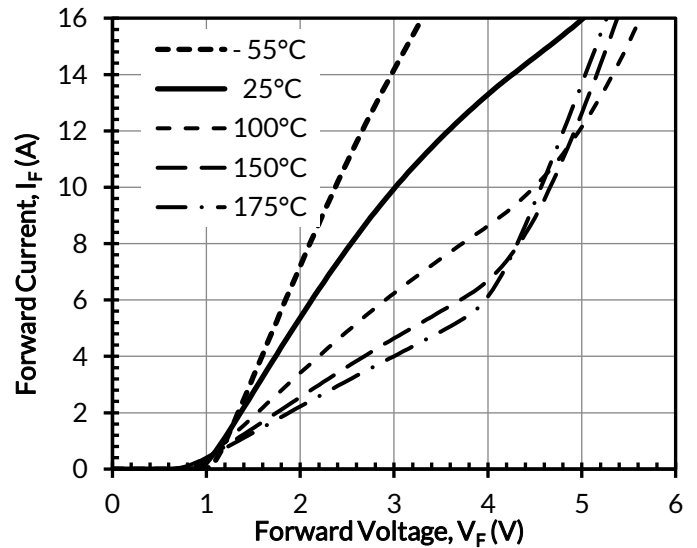

Figure 2. Typical forward characteristics in surge current

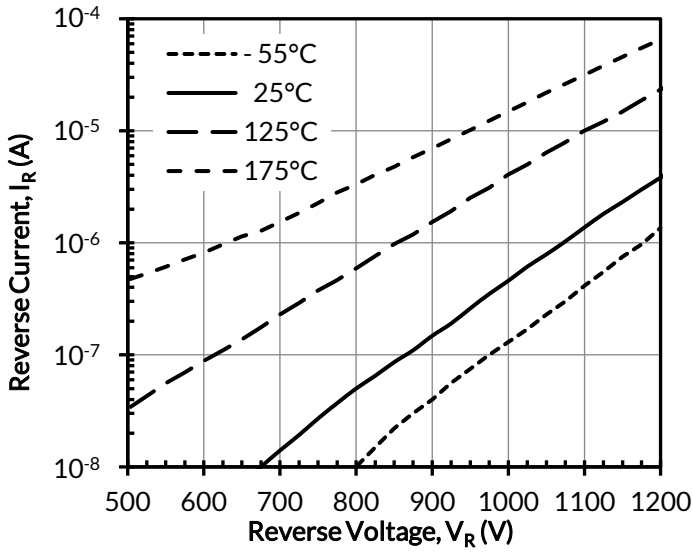

Figure 3. Typical reverse characteristics

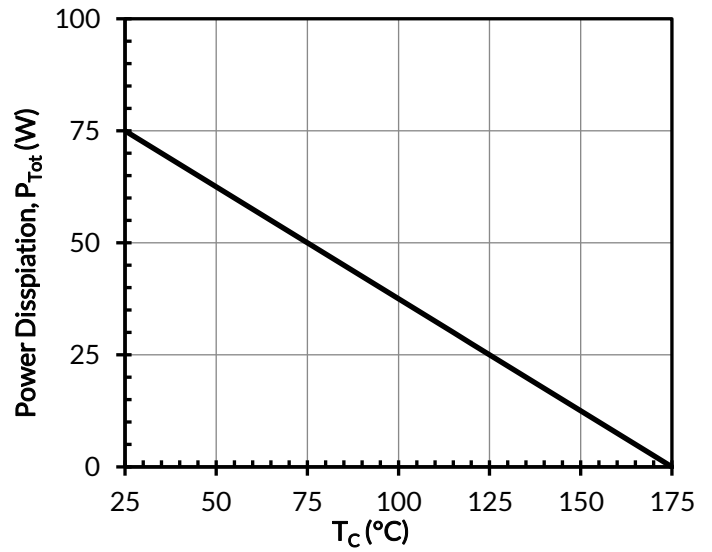

Figure 4. Power dissipation

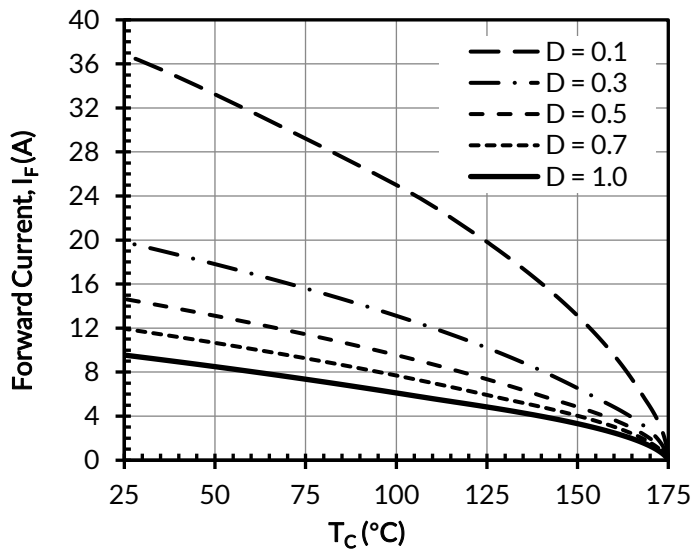

Figure 5. Diode forward current

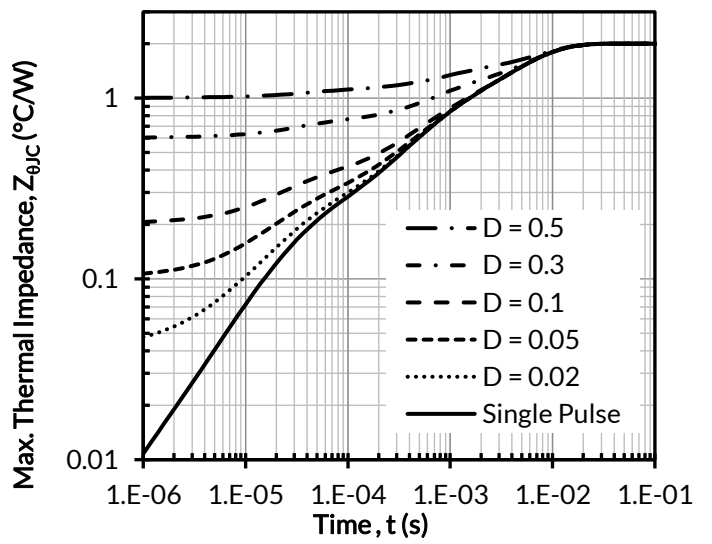

Figure 6. Maximum transient thermal impedance

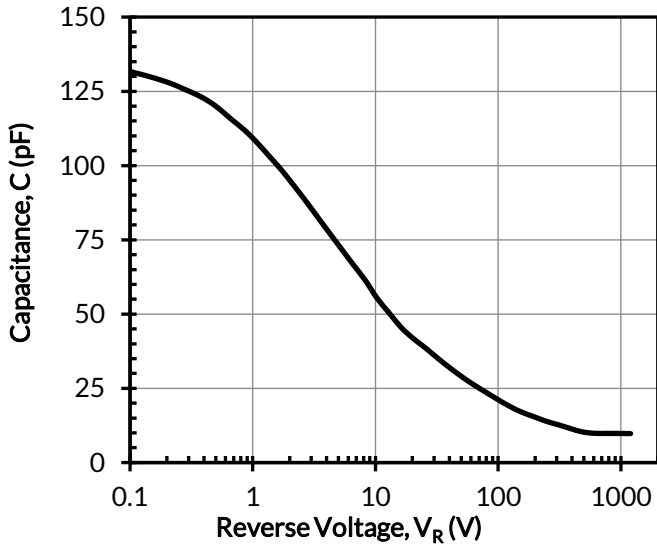

Figure 7. Capacitance vs. reverse voltage at 1MHz

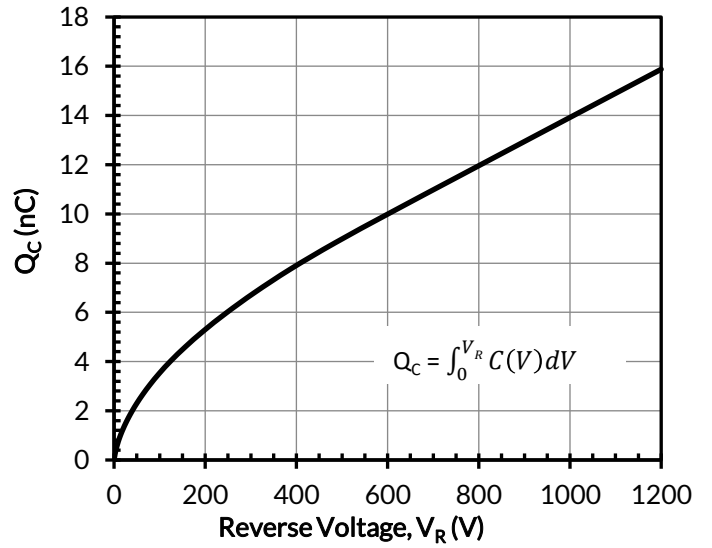

Figure 8. Typical capacitive charge vs. reverse voltage

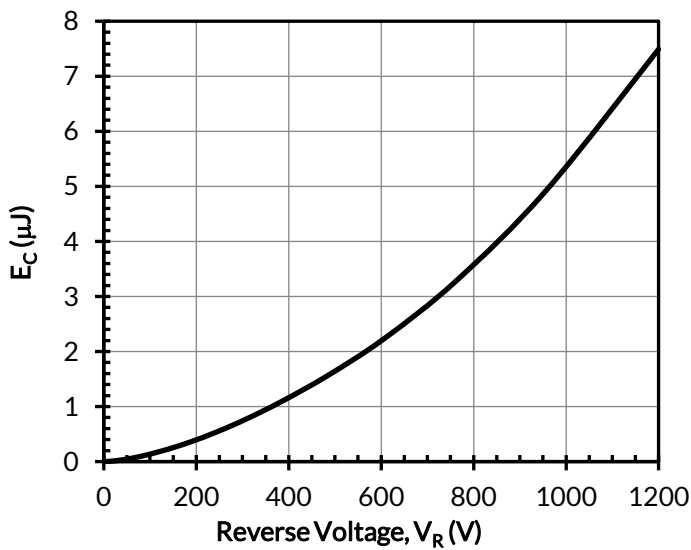

Figure 9. Typical capacitance stored energy vs. reverse voltage

## Disclaimer

UnitedSiC reserves the right to change or modify any of the products and their inherent physical and technical specifications without prior notice. UnitedSiC assumes no responsibility or liability for any errors or inaccuracies within.

Information on all products and contained herein is intended for description only. No license, express or implied, to any intellectual property rights is granted within this document.

UnitedSiC assumes no liability whatsoever relating to the choice, selection or use of the UnitedSiC products and services described herein.

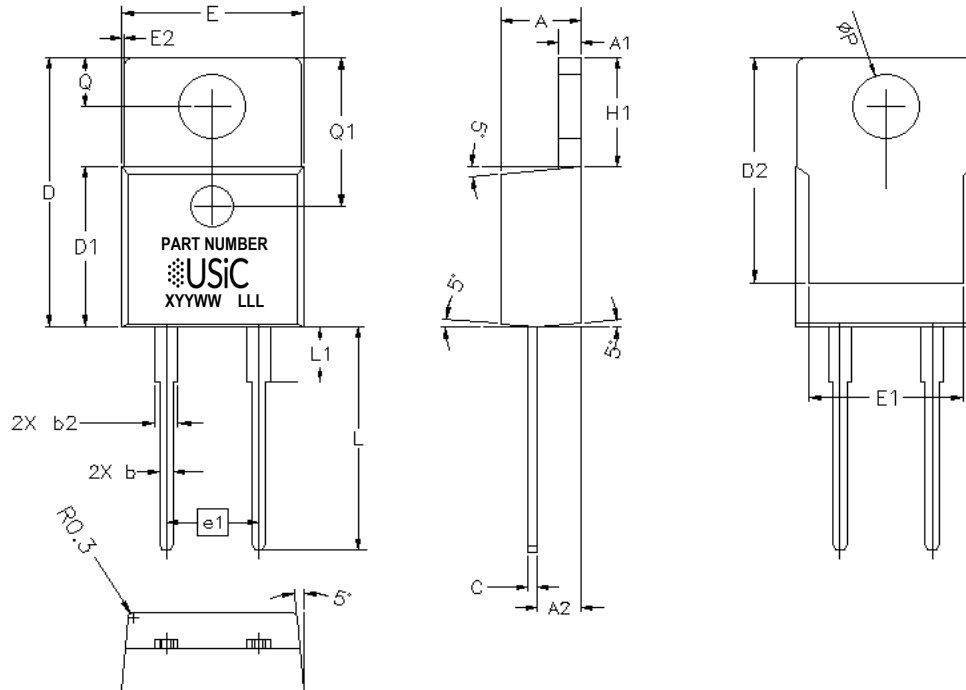
**PACKAGE OUTLINE**

DIM	INCHES		MILLIMETERS	
	MIN	MAX	MIN	MAX
A	0.140	0.190	3.56	4.83
A1	0.020	0.055	0.51	1.40
A2	0.080	0.115	2.03	2.92
b	0.015	0.040	0.38	1.02
b2	0.040	0.070	1.02	1.78
C	0.014	0.030	0.36	0.76
D	0.560	0.650	14.22	16.51
D1	0.330	0.370	8.38	9.40
D2	0.480	0.517	12.19	13.13
E	0.380	0.420	9.65	10.67
e1	0.200 BSC		5.08 BSC	
E1	0.270	0.350	6.86	8.89
E2	-	0.030		0.76
L	0.495	0.580	12.57	14.73
L1	-	0.250	-	6.35
ØP	0.139	0.161	3.53	4.09
H	0.230	0.270	5.84	6.86
Q	0.100	0.135	2.54	3.43
Q1	0.330	0.340	8.38	8.64



**PART MARKING**

**PART NUMBER**  
  
**XYYWW LLL**

PART NUMBER = REFER TO  
DS\_PN DECODER FOR DETAILS

X = ASSEMBLY SITE

YY = YEAR

WW = WORK WEEK

LLL = LOT ID

**PACKING TYPE**

ANTI-STATIC TUBE

QUANTITY /TUBE : 50 UNITS

**DISCLAIMER**

United Silicon Carbide, Inc. reserves the right to change or modify any of the products and their inherent physical and technical specifications without prior notice. United Silicon Carbide, Inc. assumes no responsibility or liability for any errors or inaccuracies within.

Information on all products and contained herein is intended for description only. No license, express or implied, to any intellectual property rights is granted within this document.

United Silicon Carbide, Inc. assumes no liability whatsoever relating to the choice, selection or use of the United Silicon Carbide, Inc. products and services described herein.

**onsemi**, **Onsemi**, and other names, marks, and brands are registered and/or common law trademarks of Semiconductor Components Industries, LLC dba "**onsemi**" or its affiliates and/or subsidiaries in the United States and/or other countries. **onsemi** owns the rights to a number of patents, trademarks, copyrights, trade secrets, and other intellectual property. A listing of **onsemi**'s product/patent coverage may be accessed at [www.onsemi.com/site/pdf/Patent-Marking.pdf](http://www.onsemi.com/site/pdf/Patent-Marking.pdf). **onsemi** reserves the right to make changes at any time to any products or information herein, without notice. The information herein is provided "as-is" and **onsemi** makes no warranty, representation or guarantee regarding the accuracy of the information, product features, availability, functionality, or suitability of its products for any particular purpose, nor does **onsemi** assume any liability arising out of the application or use of any product or circuit, and specifically disclaims any and all liability, including without limitation special, consequential or incidental damages. Buyer is responsible for its products and applications using **onsemi** products, including compliance with all laws, regulations and safety requirements or standards, regardless of any support or applications information provided by **onsemi**. "Typical" parameters which may be provided in **onsemi** data sheets and/or specifications can and do vary in different applications and actual performance may vary over time. All operating parameters, including "Typicals" must be validated for each customer application by customer's technical experts. **onsemi** does not convey any license under any of its intellectual property rights nor the rights of others. **onsemi** products are not designed, intended, or authorized for use as a critical component in life support systems or any FDA Class 3 medical devices or medical devices with a same or similar classification in a foreign jurisdiction or any devices intended for implantation in the human body. Should Buyer purchase or use **onsemi** products for any such unintended or unauthorized application, Buyer shall indemnify and hold **onsemi** and its officers, employees, subsidiaries, affiliates, and distributors harmless against all claims, costs, damages, and expenses, and reasonable attorney fees arising out of, directly or indirectly, any claim of personal injury or death associated with such unintended or unauthorized use, even if such claim alleges that **onsemi** was negligent regarding the design or manufacture of the part. **onsemi** is an Equal Opportunity/Affirmative Action Employer. This literature is subject to all applicable copyright laws and is not for resale in any manner.

## ADDITIONAL INFORMATION

### TECHNICAL PUBLICATIONS:

Technical Library: [www.onsemi.com/design/resources/technical-documentation](http://www.onsemi.com/design/resources/technical-documentation)  
onsemi Website: [www.onsemi.com](http://www.onsemi.com)

### ONLINE SUPPORT: [www.onsemi.com/support](http://www.onsemi.com/support)

For additional information, please contact your local Sales Representative at [www.onsemi.com/support/sales](http://www.onsemi.com/support/sales)