

QORVO

SiC JFET Division

Is Now Part of

onsemi™

To learn more about onsemi™, please visit our website at
www.onsemi.com

onsemi and **onsemi** and other names, marks, and brands are registered and/or common law trademarks of Semiconductor Components Industries, LLC dba "**onsemi**" or its affiliates and/or subsidiaries in the United States and/or other countries. **onsemi** owns the rights to a number of patents, trademarks, copyrights, trade secrets, and other intellectual property. A listing of **onsemi** product/patent coverage may be accessed at www.onsemi.com/site/pdf/Patent-Marking.pdf. **onsemi** reserves the right to make changes at any time to any products or information herein, without notice. The information herein is provided "as-is" and **onsemi** makes no warranty, representation or guarantee regarding the accuracy of the information, product features, availability, functionality, or suitability of its products for any particular purpose, nor does **onsemi** assume any liability arising out of the application or use of any product or circuit, and specifically disclaims any and all liability, including without limitation special, consequential or incidental damages. Buyer is responsible for its products and applications using **onsemi** products, including compliance with all laws, regulations and safety requirements or standards, regardless of any support or applications information provided by **onsemi**. "Typical" parameters which may be provided in **onsemi** data sheets and/or specifications can and do vary in different applications and actual performance may vary over time. All operating parameters, including "Typicals" must be validated for each customer application by customer's technical experts. **onsemi** does not convey any license under any of its intellectual property rights nor the rights of others. **onsemi** products are not designed, intended, or authorized for use as a critical component in life support systems or any FDA Class 3 medical devices or medical devices with a same or similar classification in a foreign jurisdiction or any devices intended for implantation in the human body. Should Buyer purchase or use **onsemi** products for any such unintended or unauthorized application, Buyer shall indemnify and hold **onsemi** and its officers, employees, subsidiaries, affiliates, and distributors harmless against all claims, costs, damages, and expenses, and reasonable attorney fees arising out of, directly or indirectly, any claim of personal injury or death associated with such unintended or unauthorized use, even if such claim alleges that **onsemi** was negligent regarding the design or manufacture of the part. **onsemi** is an Equal Opportunity/Affirmative Action Employer. This literature is subject to all applicable copyright laws and is not for resale in any manner. Other names and brands may be claimed as the property of others.

Description

United Silicon Carbide, Inc. offers the 3rd generation of high performance SiC Merged-PiN-Schottky (MPS) diodes. With zero reverse recovery charge and 175°C maximum junction temperature, these diodes are ideally suited for high frequency and high efficiency power systems with minimum cooling requirements.

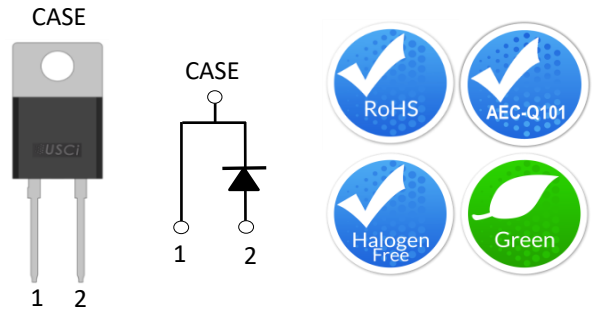

Part Number	Package	Marking
UJ3D06506TS	TO-220-2L	UJ3D06506TS

Features

- ◆ 175°C maximum operating junction temperature
- ◆ Easy paralleling
- ◆ Extremely fast switching not dependent on temperature
- ◆ No reverse or forward recovery
- ◆ Enhanced surge current capability, MPS structure
- ◆ Excellent thermal performance, Ag sintered
- ◆ 100% UIS tested
- ◆ AEC-Q101 qualified

Typical Applications

- ◆ Power converters
- ◆ Industrial motor drives
- ◆ Switching-mode power supplies
- ◆ Power factor correction modules

Maximum Ratings

Parameter	Symbol	Test Conditions	Value	Units
DC blocking voltage	V_R		650	V
Repetitive peak reverse voltage, $T_J=25^\circ\text{C}$	V_{RRM}		650	V
Surge peak reverse voltage	V_{RSM}		650	V
Maximum DC forward current	I_F	$T_C = 153^\circ\text{C}$	6	A
Non-repetitive forward surge current sine halfwave	I_{FSM}	$T_C = 25^\circ\text{C}, t_p = 10\text{ms}$	45	A
		$T_C = 110^\circ\text{C}, t_p = 10\text{ms}$	39	
Repetitive forward surge current sine halfwave, $D=0.1$	I_{FRM}	$T_C = 25^\circ\text{C}, t_p = 10\text{ms}$	29.5	A
		$T_C = 110^\circ\text{C}, t_p = 10\text{ms}$	17.9	
Non-repetitive peak forward current	$I_{F,max}$	$T_C = 25^\circ\text{C}, t_p = 10\mu\text{s}$	320	A
		$T_C = 110^\circ\text{C}, t_p = 10\mu\text{s}$	320	
i^2t value	$\int i^2 dt$	$T_C = 25^\circ\text{C}, t_p = 10\text{ms}$	10.1	A ² s
		$T_C = 110^\circ\text{C}, t_p = 10\text{ms}$	7.6	
Power dissipation	P_{Tot}	$T_C = 25^\circ\text{C}$	93.4	W
		$T_C = 153^\circ\text{C}$	13.4	
Maximum junction temperature	$T_{J,max}$		175	°C
Operating and storage temperature	T_J, T_{STG}		-55 to 175	°C
Soldering temperatures, wavesoldering only allowed at leads	T_{sold}	1.6mm from case for 10s	260	°C

Electrical Characteristics

$T_J = +25^\circ\text{C}$ unless otherwise specified

Parameter	Symbol	Test Conditions	Value			Units
			Min	Typ	Max	
Forward voltage	V_F	$I_F=6\text{A}, T_J=25^\circ\text{C}$	-	1.5	1.7	V
		$I_F=6\text{A}, T_J=150^\circ\text{C}$	-	1.8	2.1	
		$I_F=6\text{A}, T_J=175^\circ\text{C}$	-	1.9	2.25	
Reverse current	I_R	$V_R=650\text{V}, T_J=25^\circ\text{C}$	-	0.7	40	μA
		$V_R=650\text{V}, T_J=175^\circ\text{C}$	-	6		
Total capacitive charge ⁽¹⁾	Q_C	$V_R=400\text{V}$		14.5		nC
Total capacitance	C	$V_R=1\text{V}, f=1\text{MHz}$		196		pF
		$V_R=300\text{V}, f=1\text{MHz}$		24		
		$V_R=600\text{V}, f=1\text{MHz}$		21		
Capacitance stored energy	E_C	$V_R=400\text{V}$		2.2		μJ

(1) Q_C is independent on T_J , di_F/dt , and I_F as shown in the application note USCi_AN0011.

Thermal characteristics

Parameter	symbol	Test Conditions	Value			Units
			Min	Typ	Max	
Thermal resistance, junction - case	$R_{\theta JC}$			1.2	1.6	$^\circ\text{C}/\text{W}$

Typical Performance

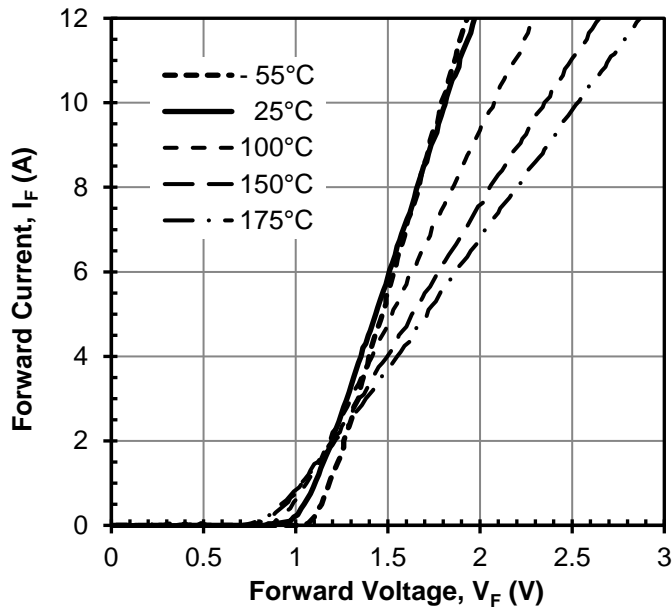

Figure 1 Typical forward characteristics

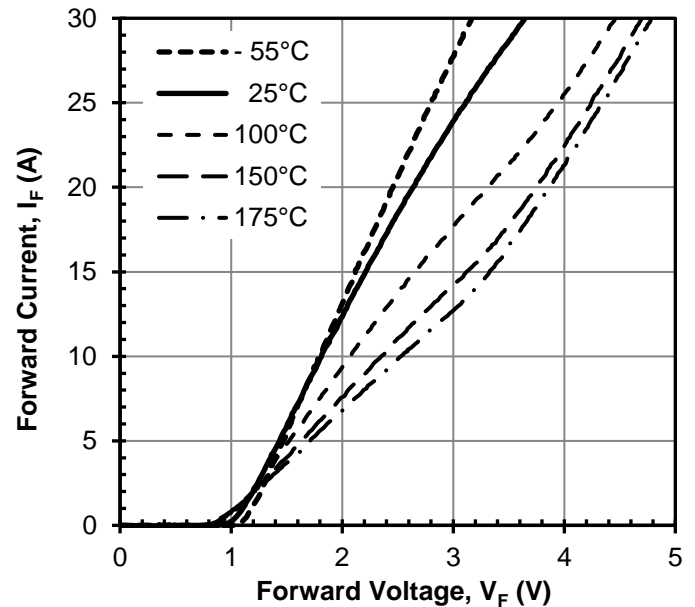

Figure 2 Typical forward characteristics in surge current

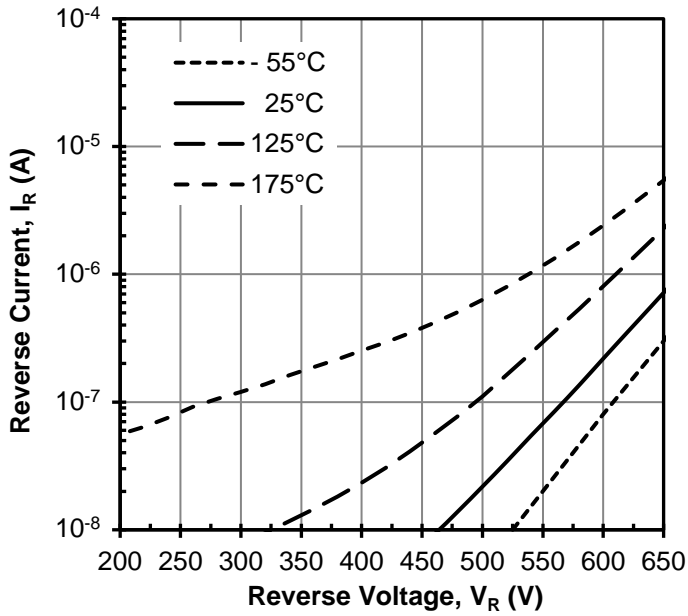

Figure 3 Typical reverse characteristics

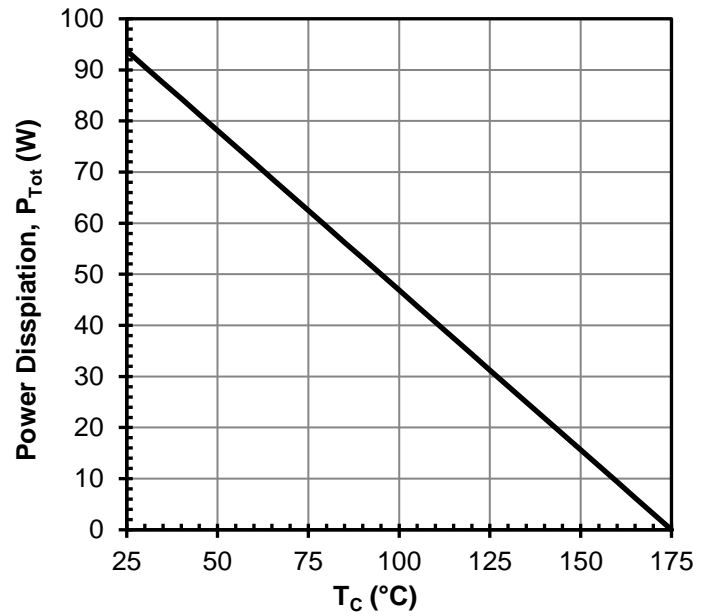

Figure 4 Power dissipation

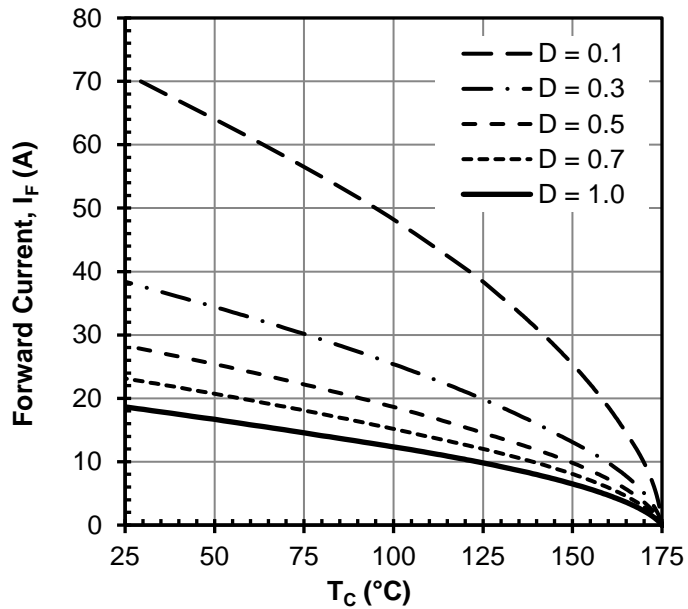

Figure 5 Diode forward current

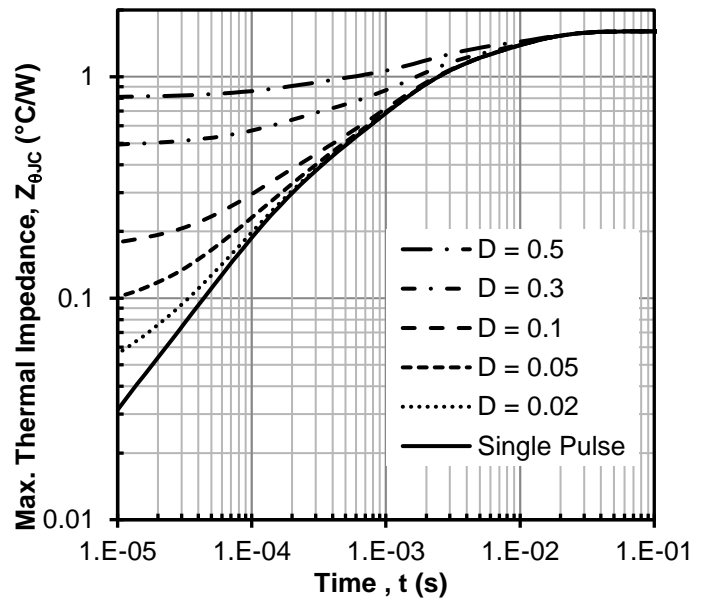

Figure 6 Maximum transient thermal impedance

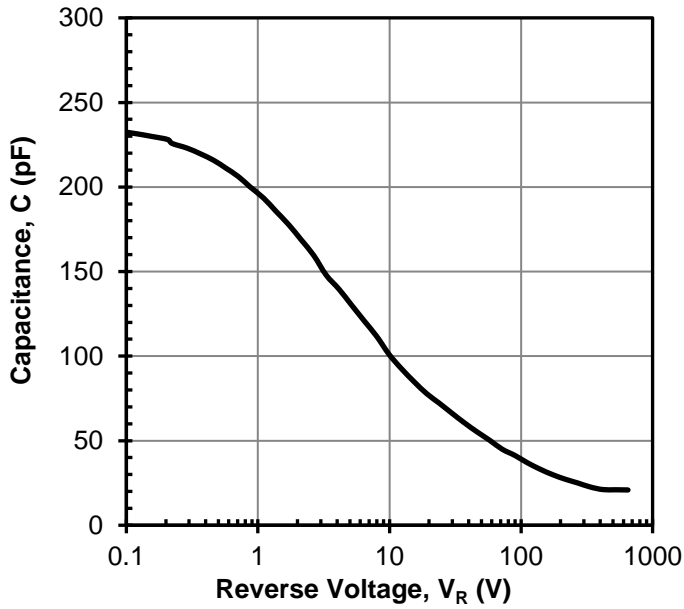

Figure 7 Capacitance vs. reverse voltage at 1MHz

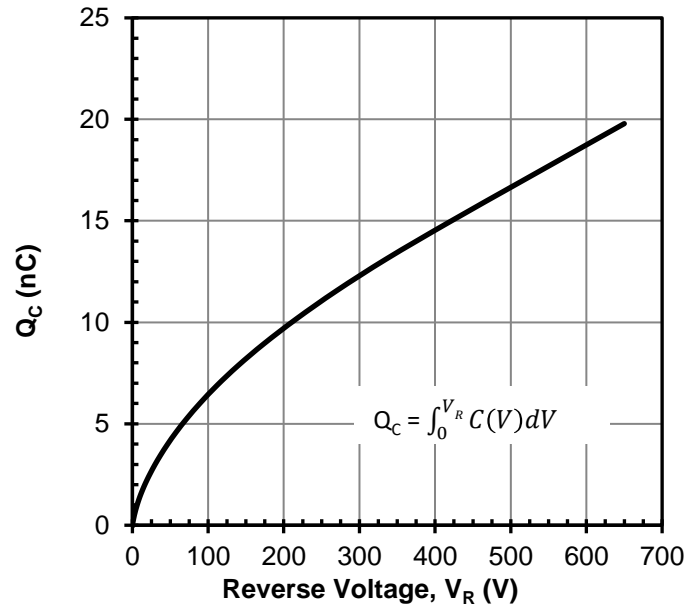

Figure 8 Typical capacitive charge vs. reverse voltage

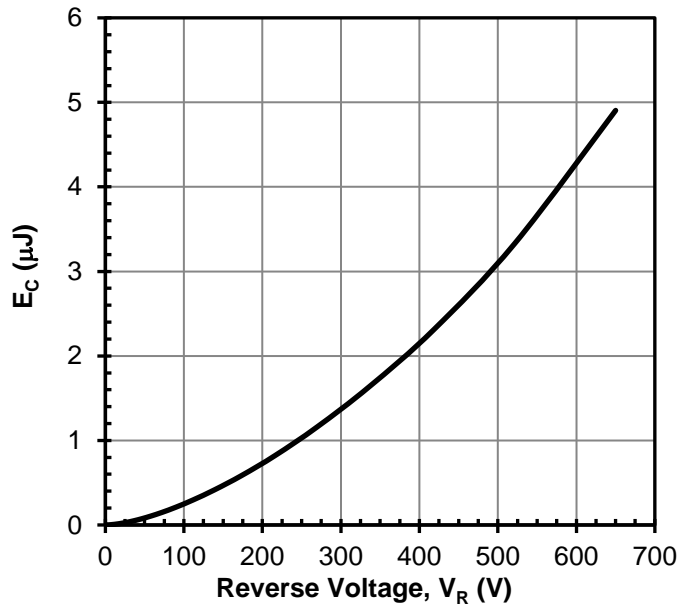

Figure 9 Typical capacitance stored energy vs. reverse voltage

Disclaimer

United Silicon Carbide, Inc. reserves the right to change or modify any of the products and their inherent physical and technical specifications without prior notice. United Silicon Carbide, Inc. assumes no responsibility or liability for any errors or inaccuracies within.

Information on all products and contained herein is intended for description only. No license, express or implied, to any intellectual property rights is granted within this document.

United Silicon Carbide, Inc. assumes no liability whatsoever relating to the choice, selection or use of the United Silicon Carbide, Inc. products and services described herein.

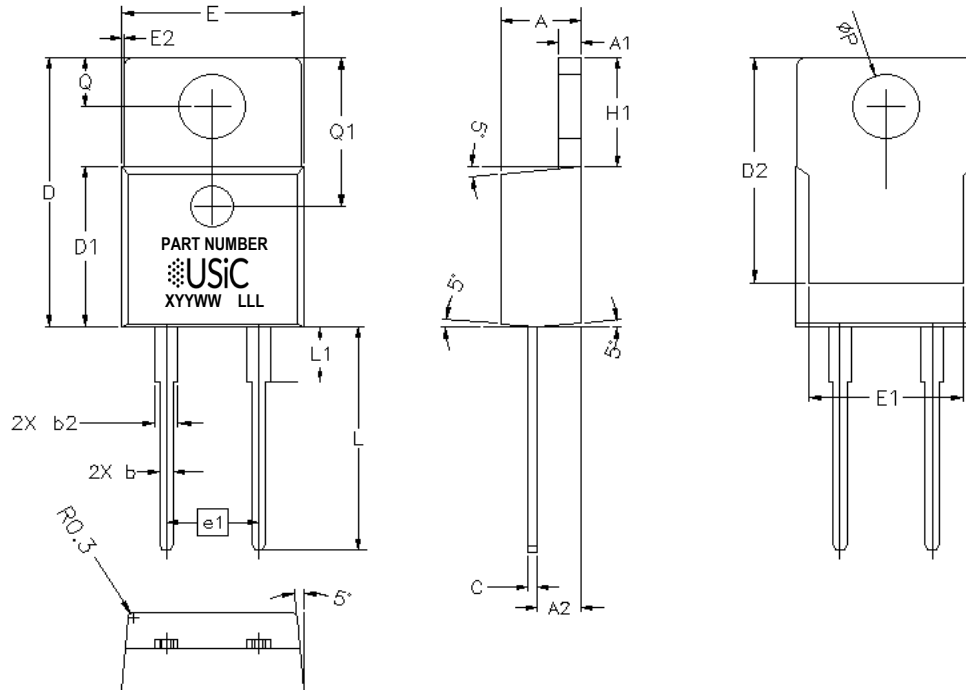
PACKAGE OUTLINE

DIM	INCHES		MILLIMETERS	
	MIN	MAX	MIN	MAX
A	0.140	0.190	3.56	4.83
A1	0.020	0.055	0.51	1.40
A2	0.080	0.115	2.03	2.92
b	0.015	0.040	0.38	1.02
b2	0.040	0.070	1.02	1.78
C	0.014	0.030	0.36	0.76
D	0.560	0.650	14.22	16.51
D1	0.330	0.370	8.38	9.40
D2	0.480	0.517	12.19	13.13
E	0.380	0.420	9.65	10.67
e1	0.200 BSC		5.08 BSC	
E1	0.270	0.350	6.86	8.89
E2	-	0.030	-	0.76
L	0.495	0.580	12.57	14.73
L1	-	0.250	-	6.35
ØP	0.139	0.161	3.53	4.09
H	0.230	0.270	5.84	6.86
Q	0.100	0.135	2.54	3.43
Q1	0.330	0.340	8.38	8.64

PART MARKING

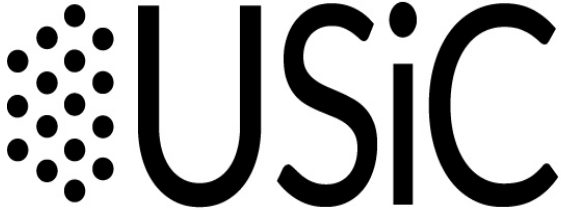
PART NUMBER

XYYWW LLL

PART NUMBER = REFER TO
DS_PN DECODER FOR DETAILS

X = ASSEMBLY SITE

YY = YEAR

WW = WORK WEEK

LLL = LOT ID

PACKING TYPE

ANTI-STATIC TUBE

QUANTITY /TUBE : 50 UNITS

DISCLAIMER

United Silicon Carbide, Inc. reserves the right to change or modify any of the products and their inherent physical and technical specifications without prior notice. United Silicon Carbide, Inc. assumes no responsibility or liability for any errors or inaccuracies within.

Information on all products and contained herein is intended for description only. No license, express or implied, to any intellectual property rights is granted within this document.

United Silicon Carbide, Inc. assumes no liability whatsoever relating to the choice, selection or use of the United Silicon Carbide, Inc. products and services described herein.

onsemi, **Onsemi**, and other names, marks, and brands are registered and/or common law trademarks of Semiconductor Components Industries, LLC dba "**onsemi**" or its affiliates and/or subsidiaries in the United States and/or other countries. **onsemi** owns the rights to a number of patents, trademarks, copyrights, trade secrets, and other intellectual property. A listing of **onsemi**'s product/patent coverage may be accessed at www.onsemi.com/site/pdf/Patent-Marking.pdf. **onsemi** reserves the right to make changes at any time to any products or information herein, without notice. The information herein is provided "as-is" and **onsemi** makes no warranty, representation or guarantee regarding the accuracy of the information, product features, availability, functionality, or suitability of its products for any particular purpose, nor does **onsemi** assume any liability arising out of the application or use of any product or circuit, and specifically disclaims any and all liability, including without limitation special, consequential or incidental damages. Buyer is responsible for its products and applications using **onsemi** products, including compliance with all laws, regulations and safety requirements or standards, regardless of any support or applications information provided by **onsemi**. "Typical" parameters which may be provided in **onsemi** data sheets and/or specifications can and do vary in different applications and actual performance may vary over time. All operating parameters, including "Typicals" must be validated for each customer application by customer's technical experts. **onsemi** does not convey any license under any of its intellectual property rights nor the rights of others. **onsemi** products are not designed, intended, or authorized for use as a critical component in life support systems or any FDA Class 3 medical devices or medical devices with a same or similar classification in a foreign jurisdiction or any devices intended for implantation in the human body. Should Buyer purchase or use **onsemi** products for any such unintended or unauthorized application, Buyer shall indemnify and hold **onsemi** and its officers, employees, subsidiaries, affiliates, and distributors harmless against all claims, costs, damages, and expenses, and reasonable attorney fees arising out of, directly or indirectly, any claim of personal injury or death associated with such unintended or unauthorized use, even if such claim alleges that **onsemi** was negligent regarding the design or manufacture of the part. **onsemi** is an Equal Opportunity/Affirmative Action Employer. This literature is subject to all applicable copyright laws and is not for resale in any manner.

ADDITIONAL INFORMATION

TECHNICAL PUBLICATIONS:

Technical Library: www.onsemi.com/design/resources/technical-documentation
onsemi Website: www.onsemi.com

ONLINE SUPPORT: www.onsemi.com/support

For additional information, please contact your local Sales Representative at www.onsemi.com/support/sales