

# QORVO

## SiC JFET Division

### Is Now Part of

# onsemi™

To learn more about onsemi™, please visit our website at  
[www.onsemi.com](http://www.onsemi.com)

**onsemi** and **onsemi** and other names, marks, and brands are registered and/or common law trademarks of Semiconductor Components Industries, LLC dba "**onsemi**" or its affiliates and/or subsidiaries in the United States and/or other countries. **onsemi** owns the rights to a number of patents, trademarks, copyrights, trade secrets, and other intellectual property. A listing of **onsemi** product/patent coverage may be accessed at [www.onsemi.com/site/pdf/Patent-Marking.pdf](http://www.onsemi.com/site/pdf/Patent-Marking.pdf). **onsemi** reserves the right to make changes at any time to any products or information herein, without notice. The information herein is provided "as-is" and **onsemi** makes no warranty, representation or guarantee regarding the accuracy of the information, product features, availability, functionality, or suitability of its products for any particular purpose, nor does **onsemi** assume any liability arising out of the application or use of any product or circuit, and specifically disclaims any and all liability, including without limitation special, consequential or incidental damages. Buyer is responsible for its products and applications using **onsemi** products, including compliance with all laws, regulations and safety requirements or standards, regardless of any support or applications information provided by **onsemi**. "Typical" parameters which may be provided in **onsemi** data sheets and/or specifications can and do vary in different applications and actual performance may vary over time. All operating parameters, including "Typicals" must be validated for each customer application by customer's technical experts. **onsemi** does not convey any license under any of its intellectual property rights nor the rights of others. **onsemi** products are not designed, intended, or authorized for use as a critical component in life support systems or any FDA Class 3 medical devices or medical devices with a same or similar classification in a foreign jurisdiction or any devices intended for implantation in the human body. Should Buyer purchase or use **onsemi** products for any such unintended or unauthorized application, Buyer shall indemnify and hold **onsemi** and its officers, employees, subsidiaries, affiliates, and distributors harmless against all claims, costs, damages, and expenses, and reasonable attorney fees arising out of, directly or indirectly, any claim of personal injury or death associated with such unintended or unauthorized use, even if such claim alleges that **onsemi** was negligent regarding the design or manufacture of the part. **onsemi** is an Equal Opportunity/Affirmative Action Employer. This literature is subject to all applicable copyright laws and is not for resale in any manner. Other names and brands may be claimed as the property of others.

# Silicon Carbide (SiC) Cascode JFET - EliteSiC, Power N-Channel, TO-247-4L, 1200 V, 16 mohm

## DATASHEET

# UF3SC120016K4S

Rev. C, January 2025

### Description

This SiC FET device is based on a unique ‘cascode’ circuit configuration, in which a normally-on SiC JFET is co-packaged with a Si MOSFET to produce a normally-off SiC FET device. The device’s standard gate-drive characteristics allows for a true “drop-in replacement” to Si IGBTs, Si FETs, SiC MOSFETs or Si superjunction devices. Available in the TO-247-4L package, this device exhibits ultra-low gate charge and exceptional reverse recovery characteristics, making it ideal for switching inductive loads, and any application requiring standard gate drive.

### Features

- ◆ Typical on-resistance  $R_{DS(on),typ}$  of 16mΩ
- ◆ Maximum operating temperature of 175°C
- ◆ Excellent reverse recovery
- ◆ Low gate charge
- ◆ Low intrinsic capacitance
- ◆ ESD protected, HBM class 2
- ◆ TO-247-4L package for faster switching, clean gate waveforms
- ◆ AECQ Qualified

### Typical applications

- ◆ EV charging
- ◆ PV inverters
- ◆ Switch mode power supplies
- ◆ Power factor correction modules
- ◆ Motor drives
- ◆ Induction heating

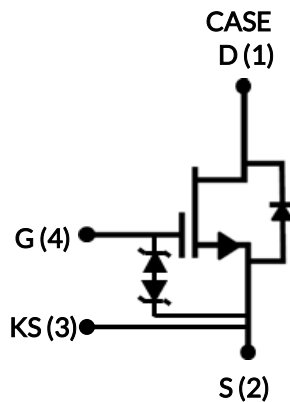

| Part Number    | Package   | Marking        |
|----------------|-----------|----------------|
| UF3SC120016K4S | TO-247-4L | UF3SC120016K4S |



## Maximum Ratings

| Parameter  | Symbol         | Test Conditions                         | Value      | Units            |
|--|----------------|---|------------|------------------|
| Drain-source voltage   | $V_{DS}$       |   | 1200       | V                |
| Gate-source voltage  | $V_{GS}$       | DC                                      | -20 to +20 | V                |
| Continuous drain current <sup>1</sup>                                | $I_D$          | $T_C = 25^\circ\text{C}$                | 107        | A                |
|  |                | $T_C = 100^\circ\text{C}$               | 77         | A                |
| Pulsed drain current <sup>2</sup>                                    | $I_{DM}$       | $T_C = 25^\circ\text{C}$                | 350        | A                |
| Single pulsed avalanche energy <sup>3</sup>                          | $E_{AS}$       | $L = 15\text{mH}, I_{AS} = 6.6\text{A}$ | 327        | mJ               |
| Power dissipation  | $P_{tot}$      | $T_C = 25^\circ\text{C}$                | 517        | W                |
| Maximum junction temperature   | $T_{J,max}$    |   | 175        | $^\circ\text{C}$ |
| Operating and storage temperature                                    | $T_J, T_{STG}$ |   | -55 to 175 | $^\circ\text{C}$ |
| Max. lead temperature for soldering,<br>1/8" from case for 5 seconds | $T_L$          |   | 250        | $^\circ\text{C}$ |

1. Limited by  $T_{J,max}$

2. Pulse width  $t_p$  limited by  $T_{J,max}$

3. Starting  $T_J = 25^\circ\text{C}$

## Thermal Characteristics

| Parameter                            | Symbol          | Test Conditions | Value |      |      | Units                     |
|--------------------------------------|-----------------|-----------------|-------|------|------|---------------------------|
|                                      |                 |                 | Min   | Typ  | Max  |                           |
| Thermal resistance, junction-to-case | $R_{\theta JC}$ |                 |       | 0.22 | 0.29 | $^\circ\text{C}/\text{W}$ |

## Electrical Characteristics ( $T_J = +25^\circ\text{C}$ unless otherwise specified)

### Typical Performance - Static

| Parameter                      | Symbol       | Test Conditions                                       | Value |     |          | Units         |
|--------------------------------|--------------|---|-------|-----|----------|---------------|
|                                |              |   | Min   | Typ | Max      |               |
| Drain-source breakdown voltage | $BV_{DS}$    | $V_{GS}=0V, I_D=1mA$                                  | 1200  |     |          | V             |
| Total drain leakage current    | $I_{DSS}$    | $V_{DS}=1200V, V_{GS}=0V, T_J=25^\circ\text{C}$       |       | 1.2 | 300      | $\mu\text{A}$ |
|                                |              | $V_{DS}=1200V, V_{GS}=0V, T_J=175^\circ\text{C}$      |       | 3.7 |          |               |
| Total gate leakage current     | $I_{GSS}$    | $V_{DS}=0V, T_J=25^\circ\text{C}, V_{GS}=-20V / +20V$ |       | 4.5 | $\pm 20$ | $\mu\text{A}$ |
| Drain-source on-resistance     | $R_{DS(on)}$ | $V_{GS}=12V, I_D=50A, T_J=25^\circ\text{C}$           |       | 16  | 21       | m $\Omega$    |
|                                |              | $V_{GS}=12V, I_D=50A, T_J=125^\circ\text{C}$          |       | 25  |          |               |
|                                |              | $V_{GS}=12V, I_D=50A, T_J=175^\circ\text{C}$          |       | 33  |          |               |
| Gate threshold voltage         | $V_{G(th)}$  | $V_{DS}=5V, I_D=10mA$                                 | 4     | 4.7 | 6        | V             |
| Gate resistance                | $R_G$        | f=1MHz, open drain                                    |       | 0.8 | 1.5      | $\Omega$      |

### Typical Performance - Reverse Diode

| Parameter                                     | Symbol        | Test Conditions  | Value |      |     | Units |
|---|---------------|--|-------|------|-----|-------|
|   |               |  | Min   | Typ  | Max |       |
| Diode continuous forward current <sup>1</sup> | $I_S$         | $T_C=25^\circ\text{C}$   |       |      | 107 | A     |
| Diode pulse current <sup>2</sup>              | $I_{S,pulse}$ | $T_C=25^\circ\text{C}$   |       |      | 350 | A     |
| Forward voltage                               | $V_{FSD}$     | $V_{GS}=0V, I_F=50A, T_J=25^\circ\text{C}$   |       | 1.47 | 2   | V     |
|   |               | $V_{GS}=0V, I_F=50A, T_J=175^\circ\text{C}$  |       | 1.95 |     |       |
| Reverse recovery charge                       | $Q_{rr}$      | $V_R=800V, I_F=80A, V_{GS}=-5V, R_{G,EXT}=5\Omega, di/dt=1750A/\mu\text{s}, T_J=25^\circ\text{C}$  |       | 605  |     | nC    |
| Reverse recovery time                         | $t_{rr}$      | $T_J=25^\circ\text{C}$   |       | 66   |     | ns    |
| Reverse recovery charge                       | $Q_{rr}$      | $V_R=800V, I_F=80A, V_{GS}=-5V, R_{G,EXT}=5\Omega, di/dt=1750A/\mu\text{s}, T_J=150^\circ\text{C}$ |       | 621  |     | nC    |
| Reverse recovery time                         | $t_{rr}$      | $T_J=150^\circ\text{C}$  |       | 72   |     | ns    |

## Typical Performance - Dynamic

| Parameter                                    | Symbol        | Test Conditions   | Value |      |     | Units   |
|--|---------------|---|-------|------|-----|---------|
|  |               |   | Min   | Typ  | Max |         |
| Input capacitance                            | $C_{iss}$     | $V_{DS}=800V, V_{GS}=0V$<br>$f=100kHz$  |       | 7824 |     | pF      |
| Output capacitance                           | $C_{oss}$     |   |       | 216  |     |         |
| Reverse transfer capacitance                 | $C_{rss}$     |   |       | 3.1  |     |         |
| Effective output capacitance, energy related | $C_{oss(er)}$ | $V_{DS}=0V$ to 800V,<br>$V_{GS}=0V$   |       | 243  |     | pF      |
| Effective output capacitance, time related   | $C_{oss(tr)}$ | $V_{DS}=0V$ to 800V,<br>$V_{GS}=0V$   |       | 540  |     | pF      |
| $C_{oss}$ stored energy                      | $E_{oss}$     | $V_{DS}=800V, V_{GS}=0V$  |       | 78   |     | $\mu J$ |
| Total gate charge                            | $Q_G$         | $V_{DS}=800V, I_D=80A,$<br>$V_{GS} = -5V$ to 15V  |       | 218  |     | nC      |
| Gate-drain charge                            | $Q_{GD}$      |   |       | 24   |     |         |
| Gate-source charge                           | $Q_{GS}$      |   |       | 96   |     |         |
| Turn-on delay time                           | $t_{d(on)}$   | $V_{DS}=800V, I_D=80A,$ Gate Driver = -5V to +15V,<br>Turn-on $R_{G,EXT}=1.5\Omega,$<br>Turn-off $R_{G,EXT}=5\Omega$<br>Inductive Load, |       | 33   |     | ns      |
| Rise time                                    | $t_r$         |   |       | 59   |     |         |
| Turn-off delay time                          | $t_{d(off)}$  |   |       | 73   |     |         |
| Fall time                                    | $t_f$         |   |       | 12   |     |         |
| Turn-on energy                               | $E_{ON}$      | FWD: same device with<br>$V_{GS} = -5V, R_G = 5\Omega,$<br>$T_J=25^\circ C$   |       | 2552 |     | $\mu J$ |
| Turn-off energy                              | $E_{OFF}$     |   |       | 150  |     |         |
| Total switching energy                       | $E_{TOTAL}$   |   |       | 2702 |     |         |
| Turn-on delay time                           | $t_{d(on)}$   | $V_{DS}=800V, I_D=80A,$ Gate Driver = -5V to +15V,<br>Turn-on $R_{G,EXT}=1.5\Omega,$<br>Turn-off $R_{G,EXT}=5\Omega$<br>Inductive Load, |       | 33   |     | ns      |
| Rise time                                    | $t_r$         |   |       | 63   |     |         |
| Turn-off delay time                          | $t_{d(off)}$  |   |       | 79   |     |         |
| Fall time                                    | $t_f$         |   |       | 12   |     |         |
| Turn-on energy                               | $E_{ON}$      | FWD: same device with<br>$V_{GS} = -5V, R_G = 5\Omega,$<br>$T_J=150^\circ C$  |       | 2820 |     | $\mu J$ |
| Turn-off energy                              | $E_{OFF}$     |   |       | 154  |     |         |
| Total switching energy                       | $E_{TOTAL}$   |   |       | 2974 |     |         |

## Typical Performance - Dynamic (continued)

| Parameter              | Symbol       | Test Conditions  | Value |      |     | Units   |
|------------------------|--------------|--|-------|------|-----|---------|
|                        |              |  | Min   | Typ  | Max |         |
| Turn-on delay time     | $t_{d(on)}$  | $V_{DS}=800V$ , $I_D=80A$ , Gate Driver = -5V to +15V,<br>Turn-on $R_{G,EXT}=1.5\Omega$ ,<br>Turn-off $R_{G,EXT}=5\Omega$<br>Inductive Load,<br>FWD: UJ3D1250K,<br>$T_J=25^\circ C$  |       | 33   |     | ns      |
| Rise time              | $t_r$        |  |       | 58   |     |         |
| Turn-off delay time    | $t_{d(off)}$ |  |       | 73   |     |         |
| Fall time              | $t_f$        |  |       | 11   |     |         |
| Turn-on energy         | $E_{ON}$     |  |       | 1815 |     | $\mu J$ |
| Turn-off energy        | $E_{OFF}$    |  |       | 140  |     |         |
| Total switching energy | $E_{TOTAL}$  |  |       | 1955 |     |         |
| Turn-on delay time     | $t_{d(on)}$  | $V_{DS}=800V$ , $I_D=80A$ , Gate Driver = -5V to +15V,<br>Turn-on $R_{G,EXT}=1.5\Omega$ ,<br>Turn-off $R_{G,EXT}=5\Omega$<br>Inductive Load,<br>FWD: UJ3D1250K,<br>$T_J=150^\circ C$ |       | 33   |     | ns      |
| Rise time              | $t_r$        |  |       | 64   |     |         |
| Turn-off delay time    | $t_{d(off)}$ |  |       | 78   |     |         |
| Fall time              | $t_f$        |  |       | 12   |     |         |
| Turn-on energy         | $E_{ON}$     |  |       | 1947 |     | $\mu J$ |
| Turn-off energy        | $E_{OFF}$    |  |       | 158  |     |         |
| Total switching energy | $E_{TOTAL}$  |  |       | 2105 |     |         |

## Typical Performance Diagrams

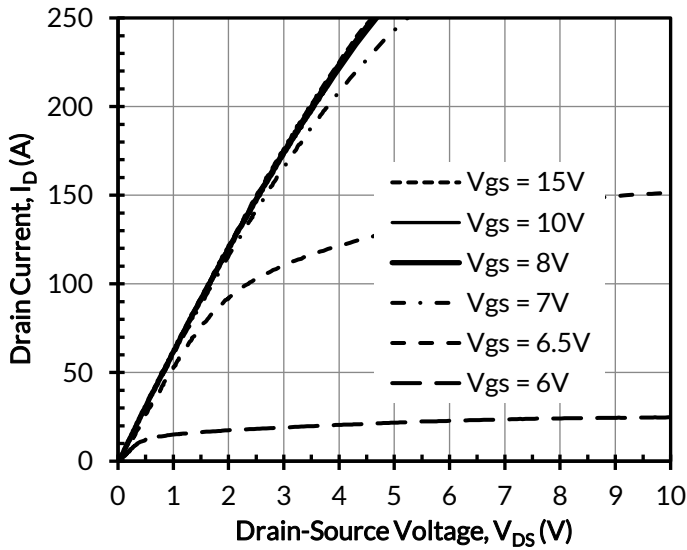

Figure 1. Typical output characteristics at  $T_J = -55^\circ\text{C}$ ,  $t_p < 250\mu\text{s}$

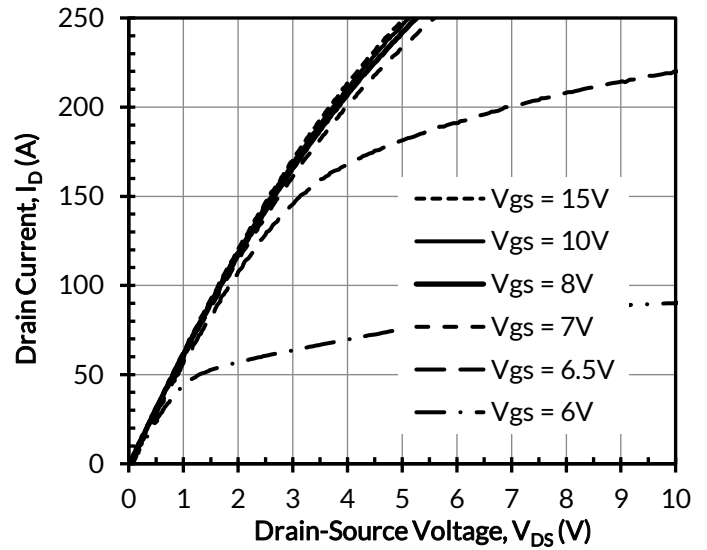

Figure 2. Typical output characteristics at  $T_J = 25^\circ\text{C}$ ,  $t_p < 250\mu\text{s}$

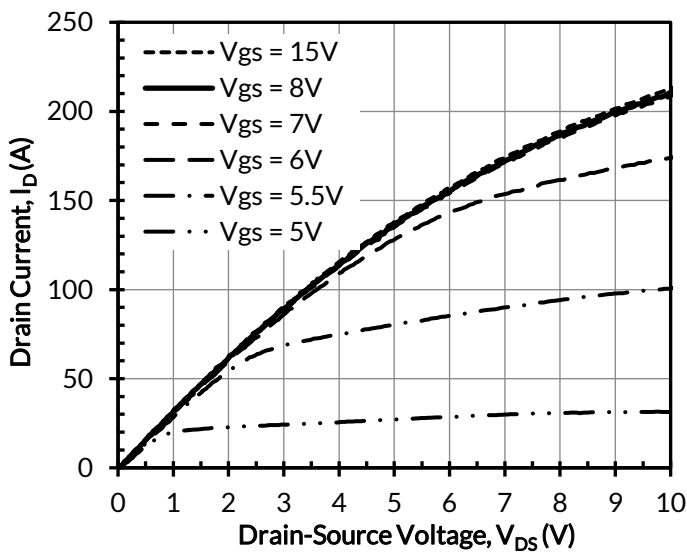

Figure 3. Typical output characteristics at  $T_J = 175^\circ\text{C}$ ,  $t_p < 250\mu\text{s}$

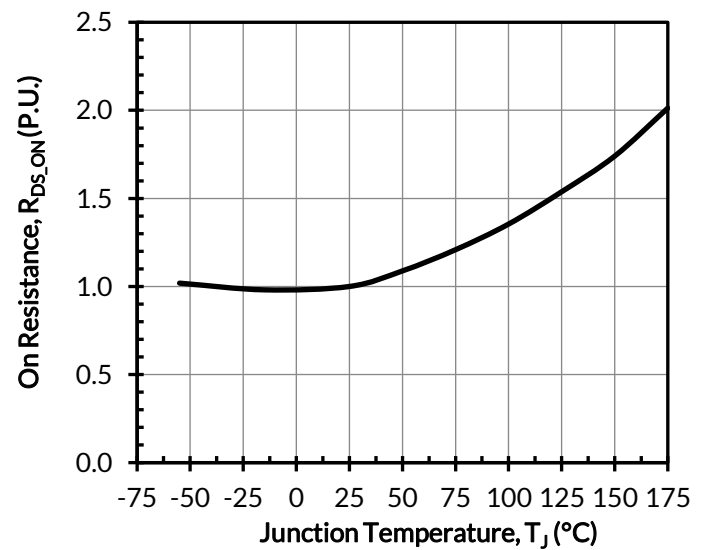

Figure 4. Normalized on-resistance vs. temperature at  $V_{GS} = 12\text{V}$  and  $I_D = 50\text{A}$

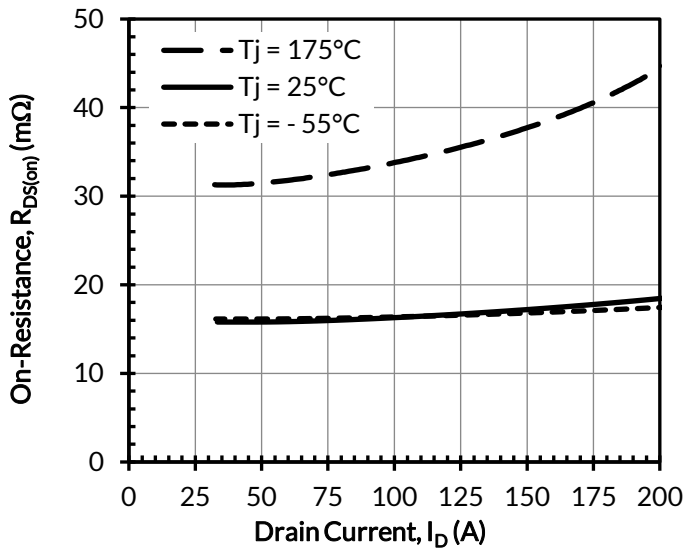

Figure 5. Typical drain-source on-resistances at  $V_{GS} = 12\text{V}$

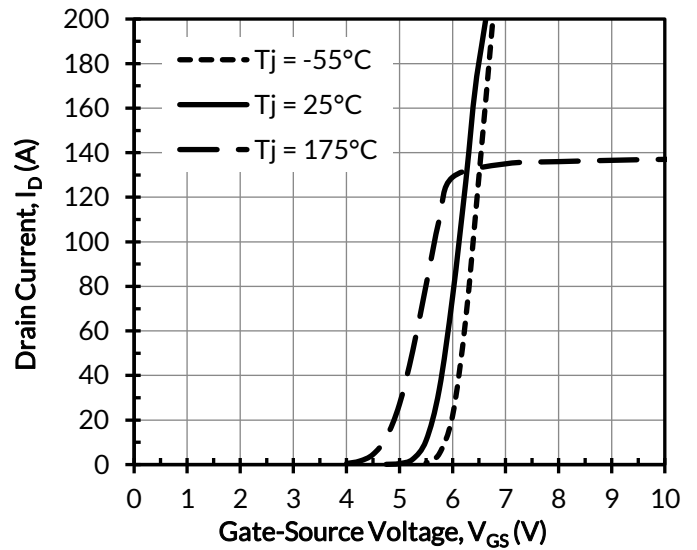

Figure 6. Typical transfer characteristics at  $V_{DS} = 5\text{V}$

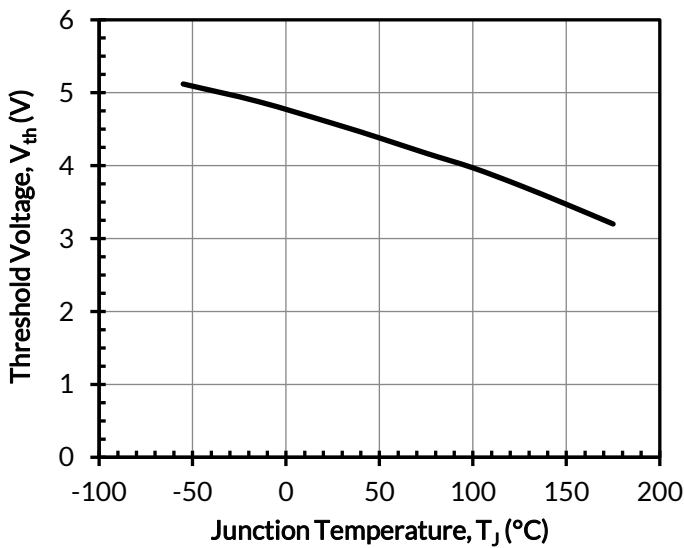

Figure 7. Threshold voltage vs. junction temperature at  $V_{DS} = 5\text{V}$  and  $I_D = 10\text{mA}$

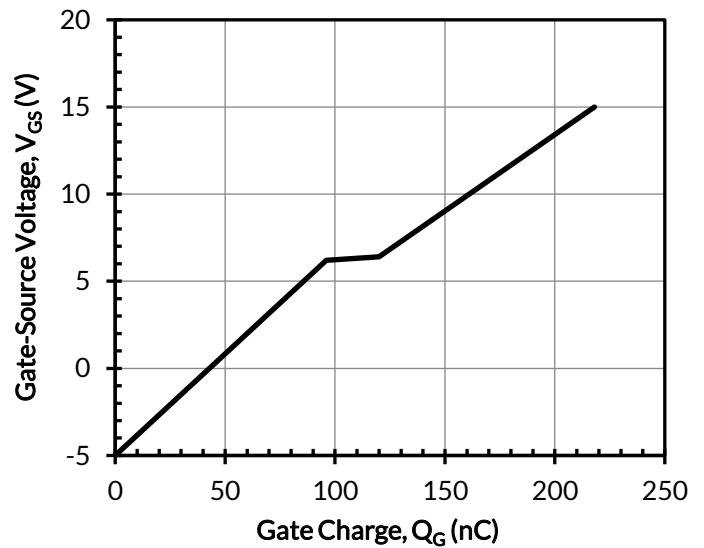

Figure 8. Typical gate charge at  $V_{DS} = 800\text{V}$  and  $I_D = 80\text{A}$



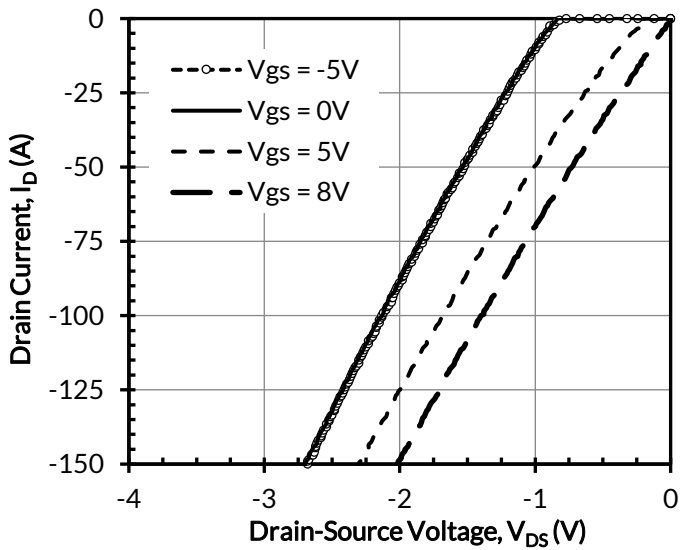

Figure 9. 3rd quadrant characteristics at  $T_j = -55^\circ\text{C}$

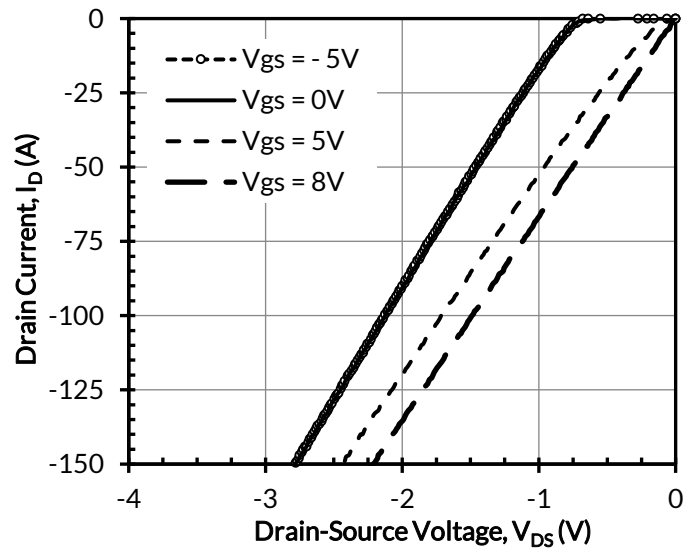

Figure 10. 3rd quadrant characteristics at  $T_j = 25^\circ\text{C}$

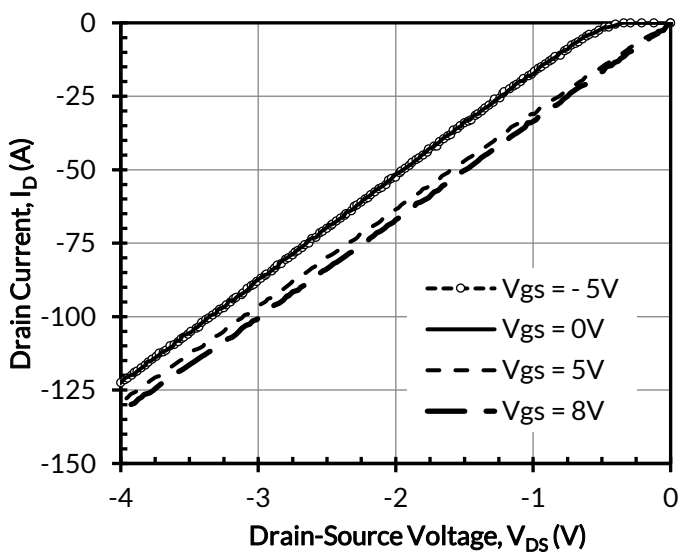

Figure 11. 3rd quadrant characteristics at  $T_j = 175^\circ\text{C}$

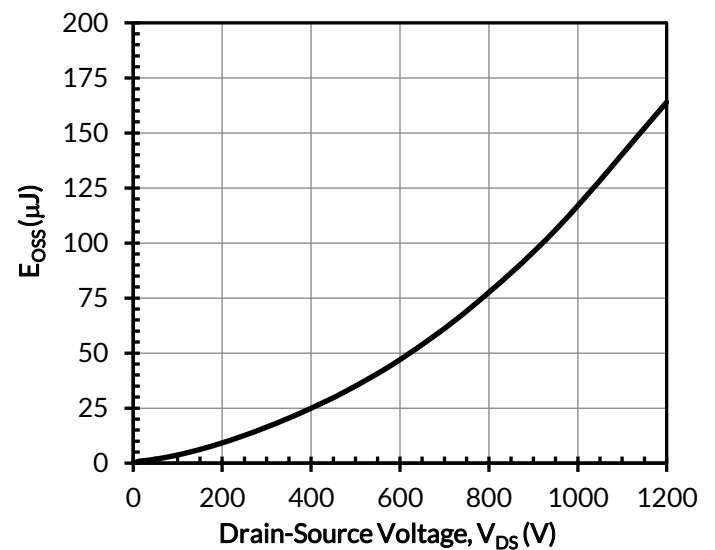

Figure 12. Typical stored energy in  $C_{OSS}$  at  $V_{GS} = 0\text{V}$

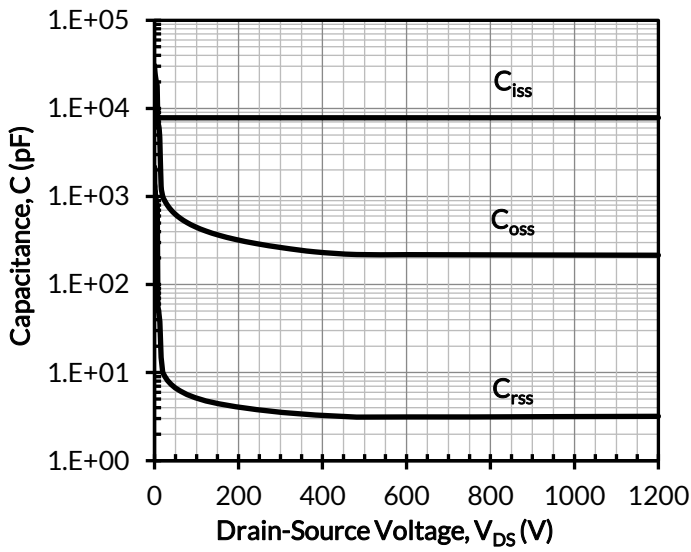

Figure 13. Typical capacitances at  $f = 100\text{kHz}$  and  $V_{GS} = 0\text{V}$

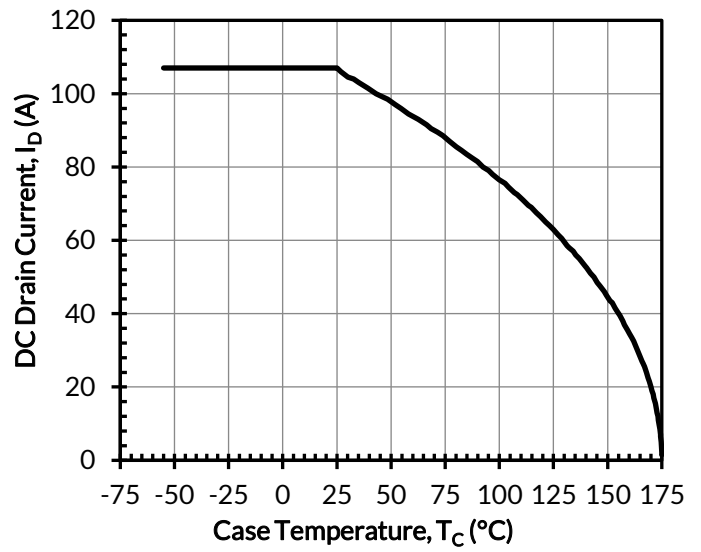

Figure 14. DC drain current derating

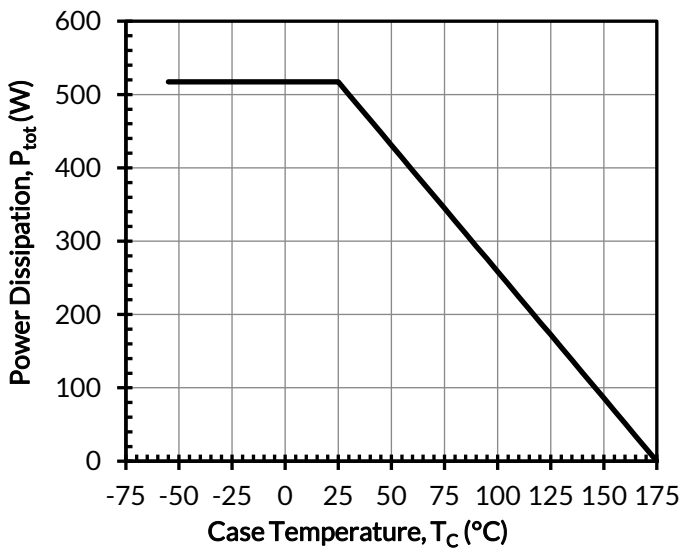

Figure 15. Total power dissipation

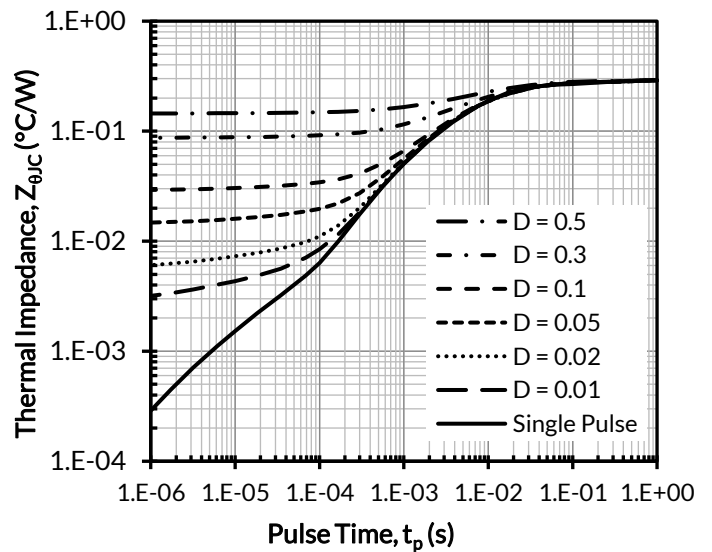

Figure 16. Maximum transient thermal impedance

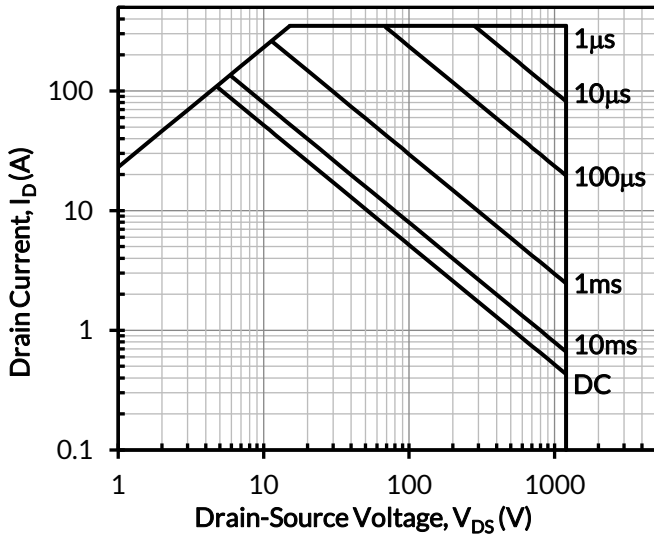

Figure 17. Safe operation area at  $T_C = 25^\circ\text{C}$ ,  $D = 0$ , Parameter  $t_p$

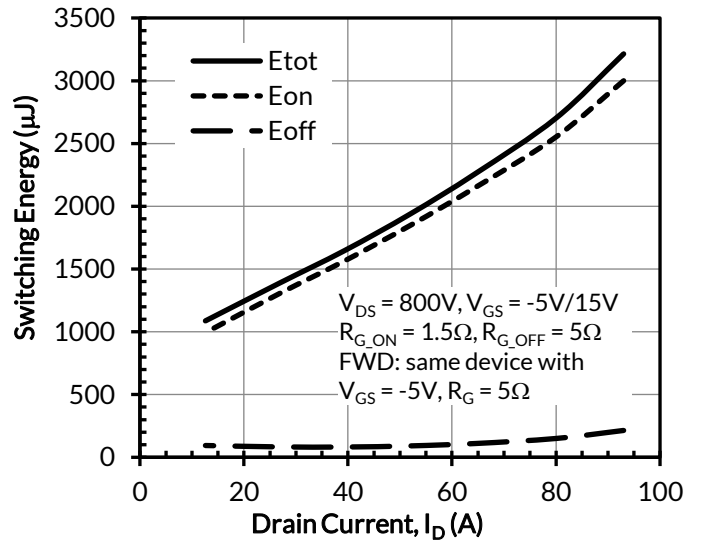

Figure 18. Clamped inductive switching energy vs. drain current at  $T_J = 25^\circ\text{C}$

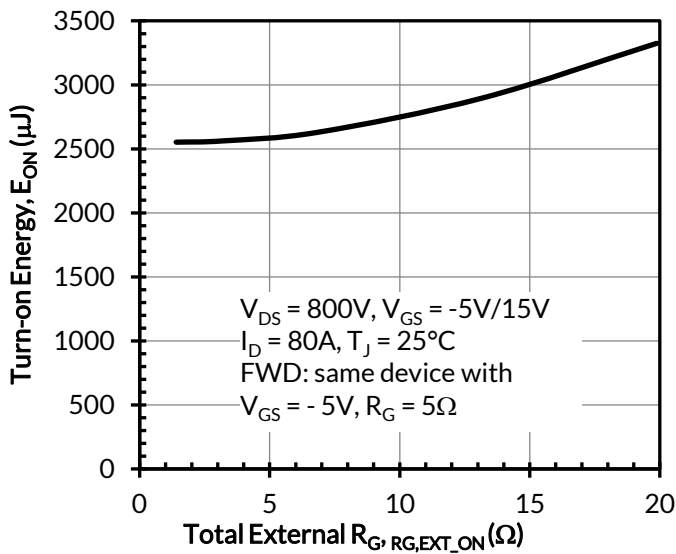

Figure 19. Clamped inductive switching turn-on energy vs.  $R_{G,EXT,ON}$

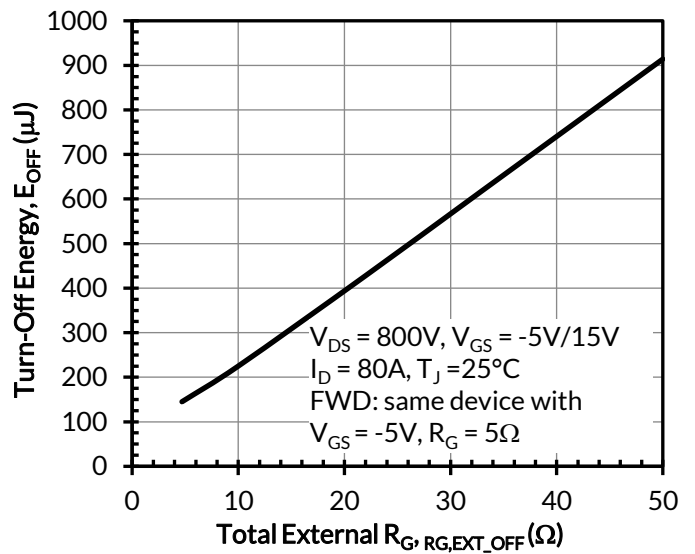

Figure 20. Clamped inductive switching turn-off energy vs.  $R_{G,EXT,OFF}$

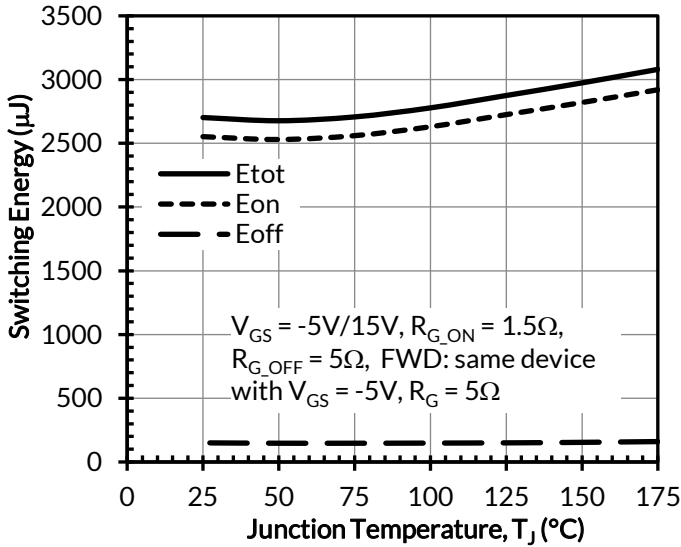

Figure 21. Clamped inductive switching energy vs. junction temperature at  $V_{DS} = 800V$  and  $I_D = 80A$

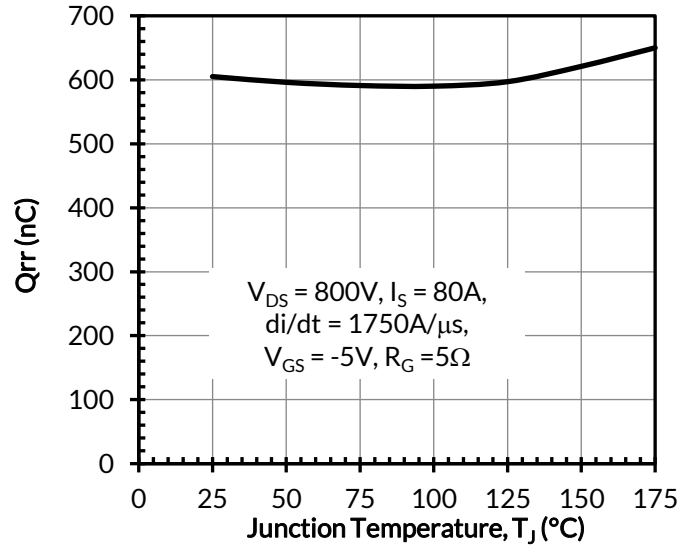

Figure 22. Reverse recovery charge  $Q_{rr}$  vs. junction temperature

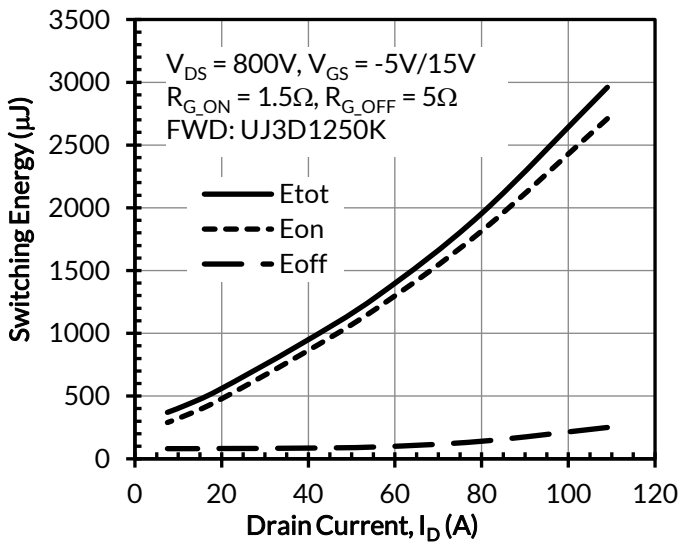

Figure 23. Clamped inductive switching energy vs. drain current at  $T_J = 25^\circ C$

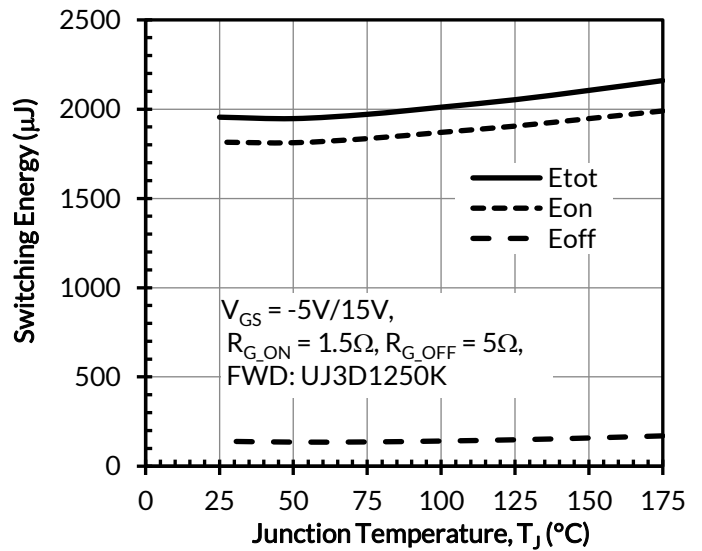

Figure 24. Clamped inductive switching energy vs. junction temperature at  $V_{DS} = 800V$  and  $I_D = 80A$

## Applications Information

SiC FETs are enhancement-mode power switches formed by a high-voltage SiC depletion-mode JFET and a low-voltage silicon MOSFET connected in series. The silicon MOSFET serves as the control unit while the SiC JFET provides high voltage blocking in the off state. This combination of devices in a single package provides compatibility with standard gate drivers and offers superior performance in terms of low on-resistance ( $R_{DS(on)}$ ), output capacitance ( $C_{oss}$ ), gate charge ( $Q_G$ ), and reverse recovery charge ( $Q_{rr}$ ) leading to low conduction and switching losses. The SiC FETs also provide excellent reverse conduction capability eliminating the need for an external anti-parallel diode.

Like other high performance power switches, proper PCB layout design to minimize circuit parasitics is strongly recommended due to the high  $dv/dt$  and  $di/dt$  rates. An external gate resistor is recommended when the FET is working in the diode mode in order to achieve the optimum reverse recovery performance. For more information on SiC FET operation, see [www.unitedsic.com](http://www.unitedsic.com).

## Disclaimer

UnitedSiC reserves the right to change or modify any of the products and their inherent physical and technical specifications without prior notice. UnitedSiC assumes no responsibility or liability for any errors or inaccuracies within.

Information on all products and contained herein is intended for description only. No license, express or implied, to any intellectual property rights is granted within this document.

UnitedSiC assumes no liability whatsoever relating to the choice, selection or use of the UnitedSiC products and services described herein.

**PACKAGE OUTLINE**

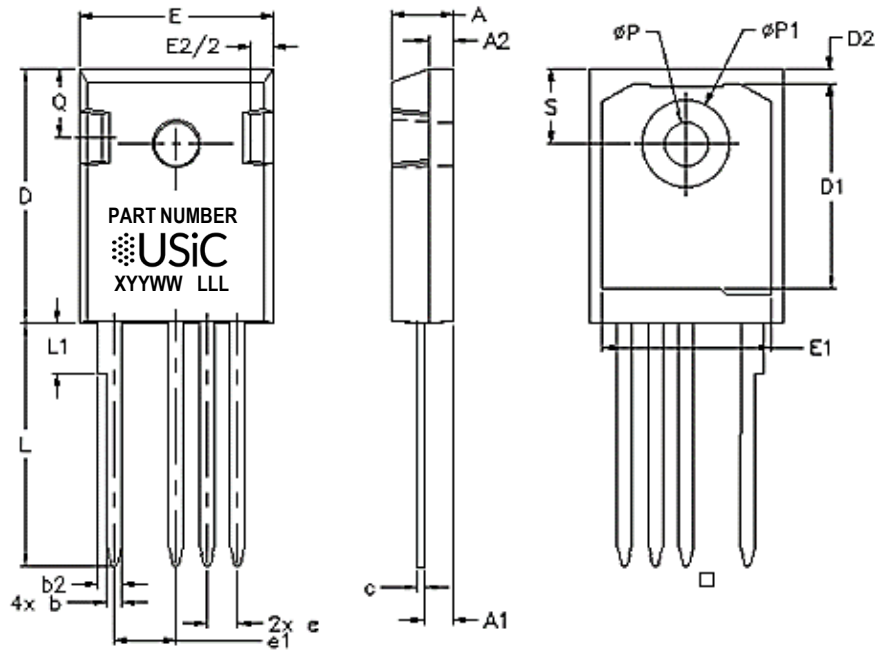

| DIM       | INCHES    |       | MILLIMETERS |       |
|-----------|-----------|-------|-------------|-------|
|           | MIN       | MAX   | MIN         | MAX   |
| A         | 0.185     | 0.209 | 4.7         | 5.31  |
| A1        | 0.087     | 0.102 | 2.21        | 2.59  |
| A2        | 0.059     | 0.098 | 1.5         | 2.49  |
| b         | 0.039     | 0.055 | 0.99        | 1.4   |
| b2        | 0.065     | 0.094 | 1.65        | 2.39  |
| c         | 0.015     | 0.035 | 0.38        | 0.89  |
| D         | 0.819     | 0.845 | 20.8        | 21.46 |
| D1        | 0.515     | -     | 13.08       | -     |
| D2        | 0.02      | 0.053 | 0.51        | 1.35  |
| E         | 0.61      | 0.64  | 15.49       | 16.26 |
| e         | 0.100 BSC |       | 2.54 BSC    |       |
| e1        | 0.19      | 0.21  | 4.83        | 5.33  |
| E1        | 0.53      | -     | 13.46       | -     |
| E2        | 0.14      | 0.16  | 3.56        | 4.06  |
| L         | 0.78      | 0.8   | 19.81       | 20.32 |
| L1        | -         | 0.177 | -           | 4.5   |
| $\phi P$  | 0.14      | 0.144 | 3.56        | 3.66  |
| $\phi P1$ | 0.278     | 0.291 | 7.06        | 7.39  |
| Q         | 0.212     | 0.244 | 5.38        | 6.2   |
| S         | 0.243 BSC |       | 6.17 BSC    |       |



## PART MARKING

# TO-247-4L PACKAGE OUTLINE, PART MARKING AND TUBE SPECIFICATIONS

# PART NUMBER

The logo for USiC, featuring a circular pattern of black dots to the left of the text "USiC" in a large, bold, black sans-serif font.  
XYYWW      LLL

PART NUMBER = REFER TO  
DS\_PN DECODER FOR DETAILS

X = ASSEMBLY SITE

YY = YEAR

WW = WORK WEEK

LLL = LOT ID

## PACKING TYPE

ANTI-STATIC TUBE

QUANTITY /TUBE : 30 UNITS

## DISCLAIMER

United Silicon Carbide, Inc. reserves the right to change or modify any of the products and their inherent physical and technical specifications without prior notice. United Silicon Carbide, Inc. assumes no responsibility or liability for any errors or inaccuracies within.

Information on all products and contained herein is intended for description only. No license, express or implied, to any intellectual property rights is granted within this document.

United Silicon Carbide, Inc. assumes no liability whatsoever relating to the choice, selection or use of the United Silicon Carbide, Inc. products and services described herein.

**onsemi**, **Onsemi**, and other names, marks, and brands are registered and/or common law trademarks of Semiconductor Components Industries, LLC dba "**onsemi**" or its affiliates and/or subsidiaries in the United States and/or other countries. **onsemi** owns the rights to a number of patents, trademarks, copyrights, trade secrets, and other intellectual property. A listing of **onsemi**'s product/patent coverage may be accessed at [www.onsemi.com/site/pdf/Patent-Marking.pdf](http://www.onsemi.com/site/pdf/Patent-Marking.pdf). **onsemi** reserves the right to make changes at any time to any products or information herein, without notice. The information herein is provided "as-is" and **onsemi** makes no warranty, representation or guarantee regarding the accuracy of the information, product features, availability, functionality, or suitability of its products for any particular purpose, nor does **onsemi** assume any liability arising out of the application or use of any product or circuit, and specifically disclaims any and all liability, including without limitation special, consequential or incidental damages. Buyer is responsible for its products and applications using **onsemi** products, including compliance with all laws, regulations and safety requirements or standards, regardless of any support or applications information provided by **onsemi**. "Typical" parameters which may be provided in **onsemi** data sheets and/or specifications can and do vary in different applications and actual performance may vary over time. All operating parameters, including "Typicals" must be validated for each customer application by customer's technical experts. **onsemi** does not convey any license under any of its intellectual property rights nor the rights of others. **onsemi** products are not designed, intended, or authorized for use as a critical component in life support systems or any FDA Class 3 medical devices or medical devices with a same or similar classification in a foreign jurisdiction or any devices intended for implantation in the human body. Should Buyer purchase or use **onsemi** products for any such unintended or unauthorized application, Buyer shall indemnify and hold **onsemi** and its officers, employees, subsidiaries, affiliates, and distributors harmless against all claims, costs, damages, and expenses, and reasonable attorney fees arising out of, directly or indirectly, any claim of personal injury or death associated with such unintended or unauthorized use, even if such claim alleges that **onsemi** was negligent regarding the design or manufacture of the part. **onsemi** is an Equal Opportunity/Affirmative Action Employer. This literature is subject to all applicable copyright laws and is not for resale in any manner.

## ADDITIONAL INFORMATION

### TECHNICAL PUBLICATIONS:

Technical Library: [www.onsemi.com/design/resources/technical-documentation](http://www.onsemi.com/design/resources/technical-documentation)  
onsemi Website: [www.onsemi.com](http://www.onsemi.com)

### ONLINE SUPPORT: [www.onsemi.com/support](http://www.onsemi.com/support)

For additional information, please contact your local Sales Representative at [www.onsemi.com/support/sales](http://www.onsemi.com/support/sales)