

MOSFET – Power, Single, N-Channel, STD Gate, SO8FL

80 V, 6.2 mΩ, 73 A

Product Preview NTMFS6D2N08X

Features

- Low QRR, Soft Recovery Body Diode
- Low RDS(on) to Minimize Conduction Losses
- Low QG and Capacitance to Minimize Driver Losses
- These Devices are Pb-Free, Halogen Free/BFR Free and are RoHS Compliant

Applications

- Synchronous Rectification (SR) in DCDC and ACDC
- Primary Switch in Isolated DCDC Converter
- Motor Drives

MAXIMUM RATINGS (T_J = 25°C unless otherwise noted)

Parameter	Symbol	Value	Unit
Drain-to-Source Voltage	V _{DSS}	80	V
Gate-to-Source Voltage	V _{GS}	±20	V
Continuous Drain Current	I _D	T _C = 25°C	73 A
		T _C = 100°C	52
Power Dissipation	P _D	68	W
Pulsed Drain Current	I _{DM}	T _C = 25°C	265 A
		t _p = 100 μs	
Operating Junction and Storage Temperature Range	T _J , T _{stg}	-55 to +175	°C
Continuous Source-Drain Current (Body Diode)	I _S	115	A
Single Pulse Avalanche Energy (I _{PK} = 28 A)	E _{AS}	39	mJ
Lead Temperature for Soldering Purposes (1/8" from case for 10 seconds)	T _L	260	°C

Stresses exceeding those listed in the Maximum Ratings table may damage the device. If any of these limits are exceeded, device functionality should not be assumed, damage may occur and reliability may be affected.

1. The entire application environment impacts the thermal resistance values shown. They are not constants and are only valid for the particular conditions noted.
2. Actual continuous current will be limited by thermal and electromechanical application board design.
3. EAS of 39 mJ is based on started T_J = 25°C, I_{AS} = 28 A, V_{DD} = 64 V, V_{GS} = 10 V, 100% avalanche tested.

This document contains information on a product under development. onsemi reserves the right to change or discontinue this product without notice.

V _{(BR)DSS}	R _{DS(ON) MAX}	I _{D MAX}
80 V	6.2 mΩ @ 10 V	73 A

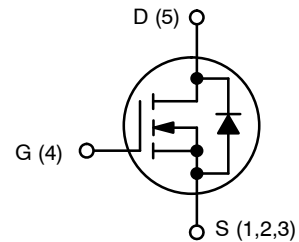

N-CHANNEL MOSFET

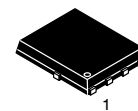

DFN5
(SO-8FL)
CASE 488AA
STYLE 1

MARKING DIAGRAM



6D2N08 = Specific Device Code
A = Assembly Location
Y = Year
W = Work Week
ZZ = Lot Traceability

ORDERING INFORMATION

Device	Package	Shipping†
NTMFS6D2N08XT1G	DFN5 (Pb-Free)	1500 / Tape & Reel

†For information on tape and reel specifications, including part orientation and tape sizes, please refer to our Tape and Reel Packaging Specification Brochure, BRD8011/D.

NTMFS6D2N08X

THERMAL CHARACTERISTICS

Parameter	Symbol	Value	Unit
Thermal Resistance, Junction-to-Case	$R_{\theta JC}$	2.2	$^{\circ}C/W$
Thermal Resistance, Junction-to-Ambient	$R_{\theta JA}$	39	

ELECTRICAL CHARACTERISTICS ($T_J = 25^{\circ}C$ unless otherwise specified)

Parameter	Symbol	Test Conditions	Min	Typ	Max	Unit
-----------	--------	-----------------	-----	-----	-----	------

OFF CHARACTERISTICS

Drain-to-Source Breakdown Voltage	$V_{(BR)DSS}$	$V_{GS} = 0 V, I_D = 1 mA, T_J = 25^{\circ}C$	80	-	-	V
Drain-to-Source Breakdown Voltage Temperature Coefficient	$\Delta V_{(BR)DSS} / \Delta T_J$	$I_D = 1 mA$, Referenced to $25^{\circ}C$	-	32	-	$mV/^{\circ}C$
Zero Gate Voltage Drain Current	I_{DSS}	$V_{DS} = 80 V, T_J = 25^{\circ}C$	-	-	1.0	μA
		$V_{DS} = 80 V, T_J = 125^{\circ}C$	-	-	250	μA
Gate-to-Source Leakage Current	I_{GSS}	$V_{GS} = 20 V, V_{DS} = 0 V$	-	-	100	nA

ON CHARACTERISTICS

Drain-to-Source On Resistance	$R_{DS(ON)}$	$V_{GS} = 10 V, I_D = 15 A, T_J = 25^{\circ}C$	-	5.1	6.2	$m\Omega$
		$V_{GS} = 6 V, I_D = 7 A, T_J = 25^{\circ}C$	-	7.7	11.8	
Gate Threshold Voltage	$V_{GS(TH)}$	$V_{GS} = V_{DS}, I_D = 75 \mu A, T_J = 25^{\circ}C$	2.4	-	3.6	V
Gate Threshold Voltage Temperature Coefficient	$\Delta V_{GS(TH)} / \Delta T_J$	$V_{GS} = V_{DS}, I_D = 75 \mu A$	-	-7	-	$mV/^{\circ}C$
Forward Transconductance	g_{FS}	$V_{DS} = 5 V, I_D = 15 A$	-	48	-	S

CHARGES, CAPACITANCES & GATE RESISTANCE

Input Capacitance	C_{ISS}	$V_{DS} = 40 V, V_{GS} = 0 V, f = 1 MHz$	-	1346	-	pF
Output Capacitance	C_{OSS}		-	388	-	
Reverse Transfer Capacitance	C_{RSS}		-	5.9	-	
Output Charge	Q_{OSS}	$V_{DD} = 40 V, I_D = 15 A, V_{GS} = 10 V$	-	28	-	nC
Total Gate Charge	$Q_{G(TOT)}$		-	19	-	
Threshold Gate Charge	$Q_{G(TH)}$		-	4.1	-	
Gate-to-Source Charge	Q_{GS}		-	6.3	-	
Gate-to-Drain Charge	Q_{GD}		-	3.0	-	
Gate Plateau Voltage	V_{GP}		-	4.7	-	
Gate Resistance	R_G	$f = 1 MHz$	-	1.6	-	Ω

SWITCHING CHARACTERISTICS

Turn-On Delay Time	$t_{d(ON)}$	Resistive Load, $V_{GS} = 0/10 V, V_{DD} = 40 V, I_D = 15 A, R_G = 2.5 \Omega$	-	9.9	-	ns
Rise Time	t_r		-	19	-	
Turn-Off Delay Time	$t_{d(OFF)}$		-	15	-	
Fall Time	t_f		-	24	-	

SOURCE-TO-DRAIN DIODE CHARACTERISTICS

Forward Diode Voltage	V_{SD}	$I_S = 15 A, V_{GS} = 0 V, T_J = 25^{\circ}C$	-	0.82	1.2	V
		$I_S = 15 A, V_{GS} = 0 V, T_J = 125^{\circ}C$	-	0.66	-	
Reverse Recovery Time	t_{RR}	$V_{GS} = 0 V, I_S = 15 A, di/dt = 1000 A/\mu s, V_{DD} = 40 V, T_J = 25^{\circ}C$	-	18	-	ns
Charge Time	t_a		-	8.7	-	
Discharge Time	t_b		-	8.8	-	
Reverse Recovery Charge	Q_{RR}		-	83	-	

Product parametric performance is indicated in the Electrical Characteristics for the listed test conditions, unless otherwise noted. Product performance may not be indicated by the Electrical Characteristics if operated under different conditions.

NTMFS6D2N08X

TYPICAL CHARACTERISTICS

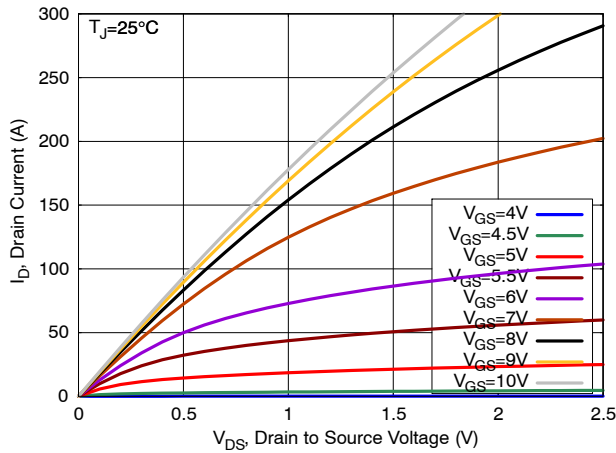

Figure 1. On-Region Characteristics

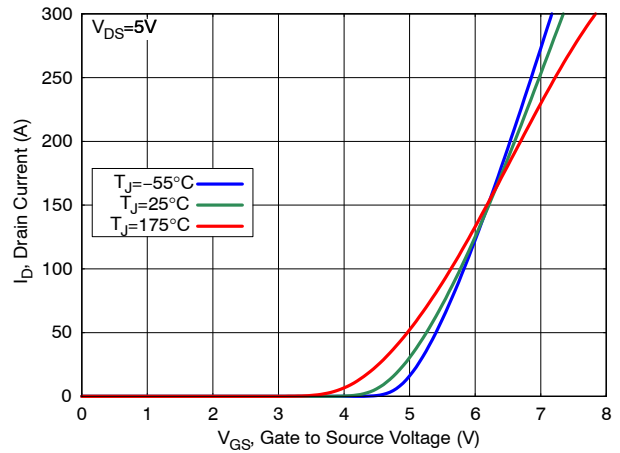

Figure 2. Transfer Characteristics

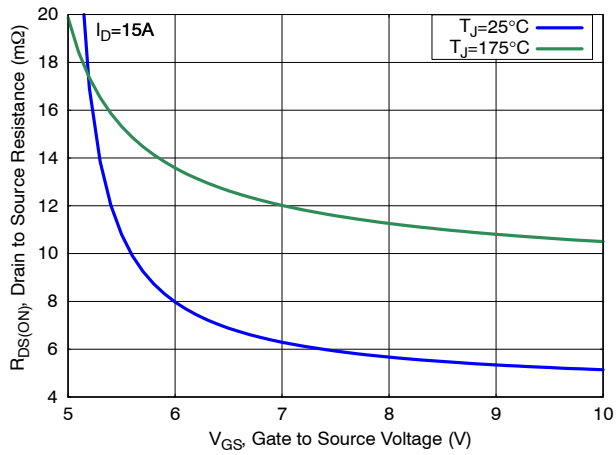

Figure 3. On-Resistance vs. Gate Voltage

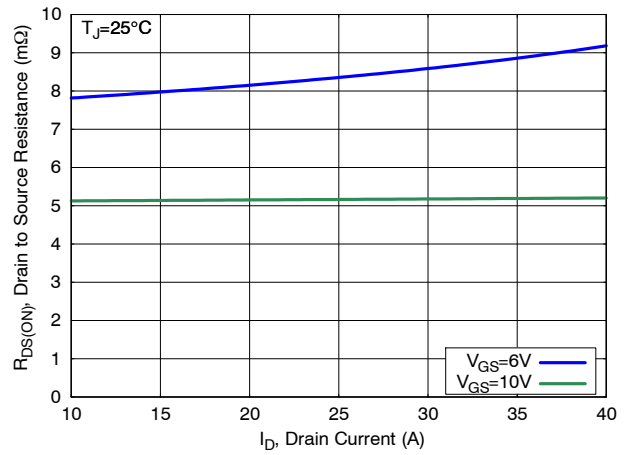

Figure 4. On-Resistance vs. Drain Current

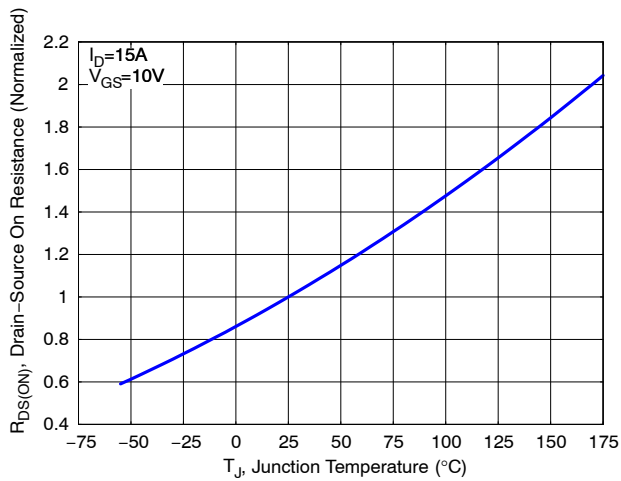

Figure 5. Normalized ON Resistance vs. Junction Temperature

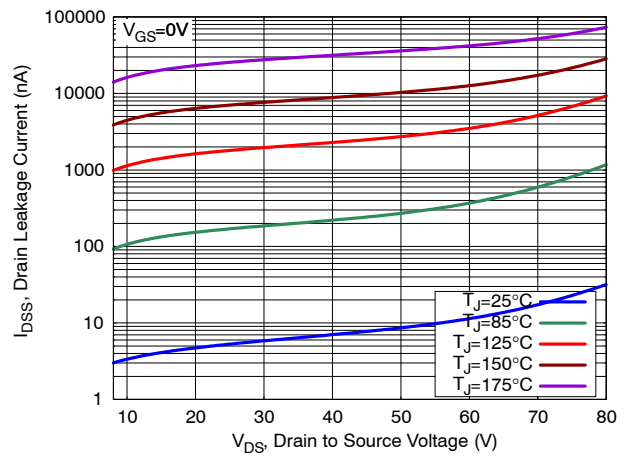

Figure 6. Drain Leakage Current vs. Drain Voltage

NTMFS6D2N08X

TYPICAL CHARACTERISTICS

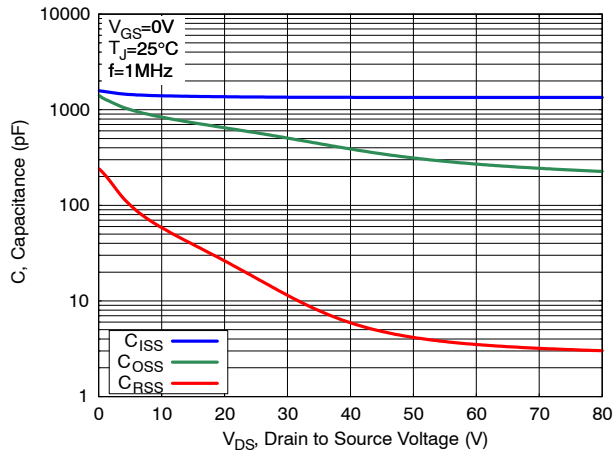

Figure 7. Capacitance Characteristics

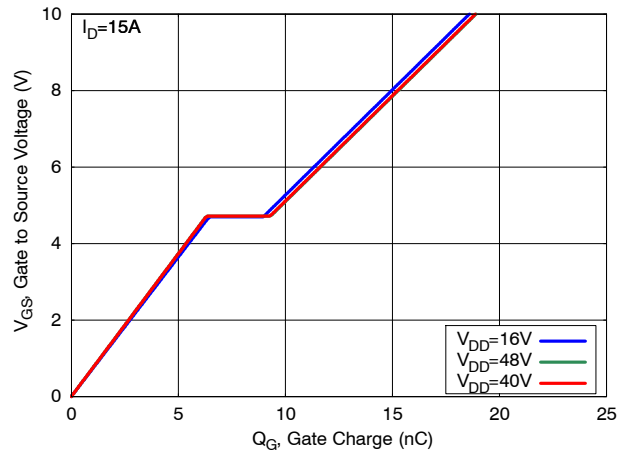

Figure 8. Gate Charge Characteristics

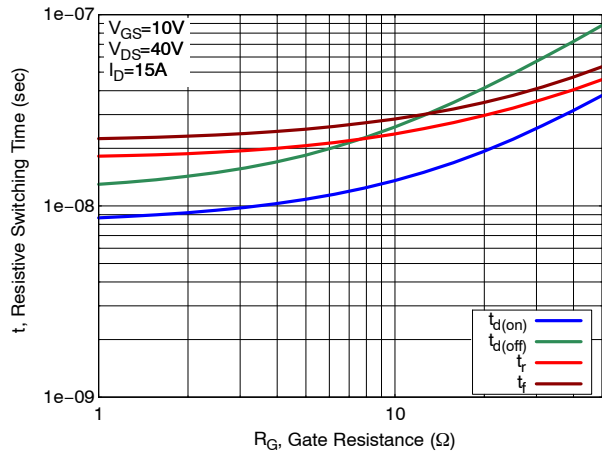

Figure 9. Resistive Switching Time Variation vs. Gate Resistance

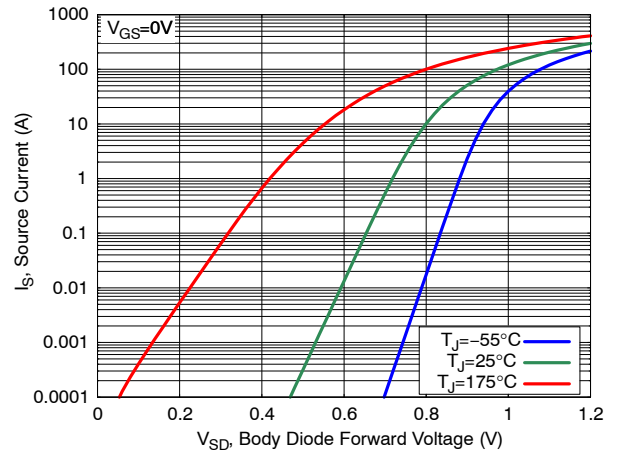

Figure 10. Diode Forward Characteristics

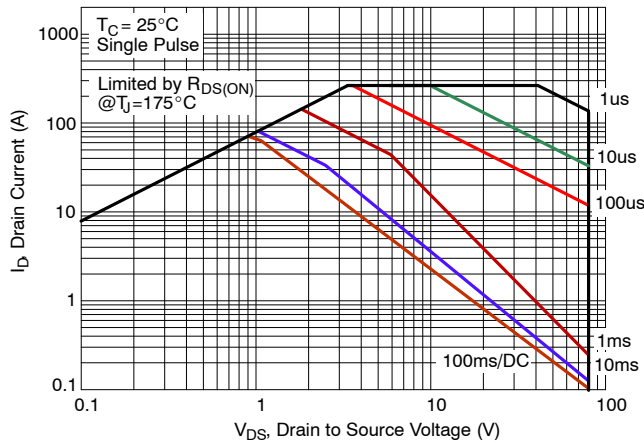

Figure 11. Safe Operating Area (SOA)

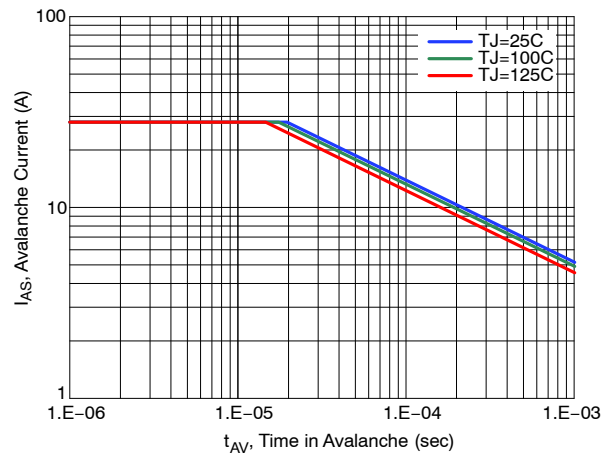

Figure 12. Avalanche Current vs. Pulse Time (UIS)

NTMFS6D2N08X

TYPICAL CHARACTERISTICS

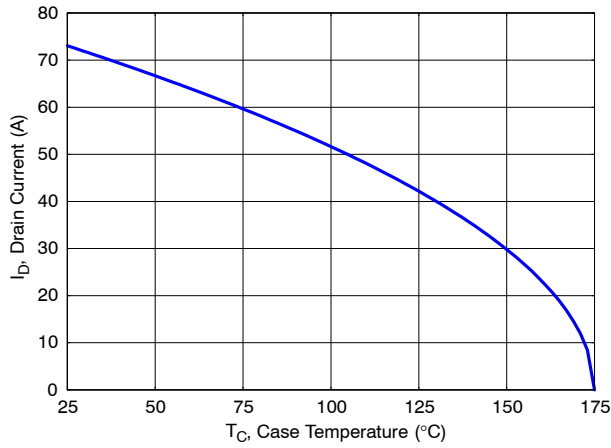

Figure 13. Maximum Current vs. Case Temperature

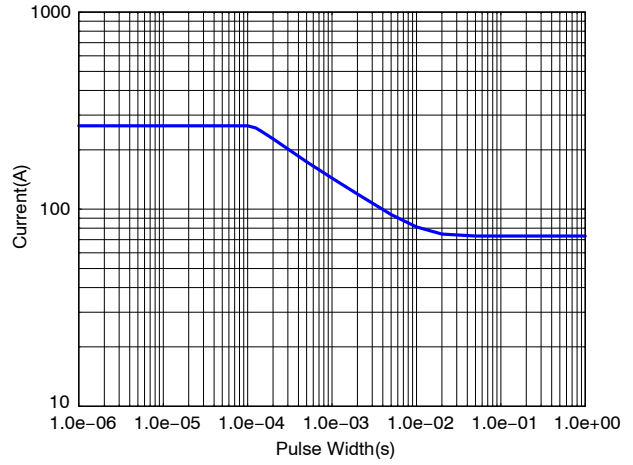

Figure 14. IDM vs. Pulse Width

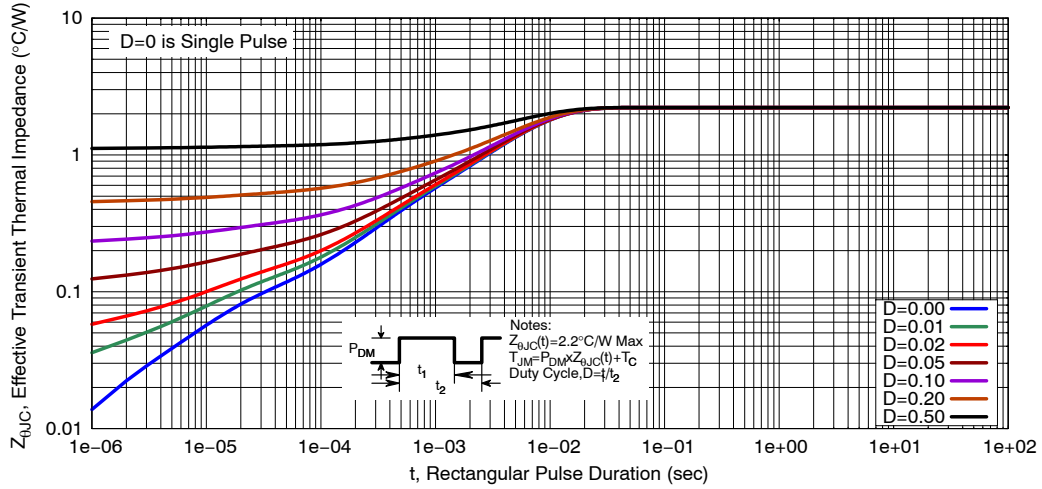
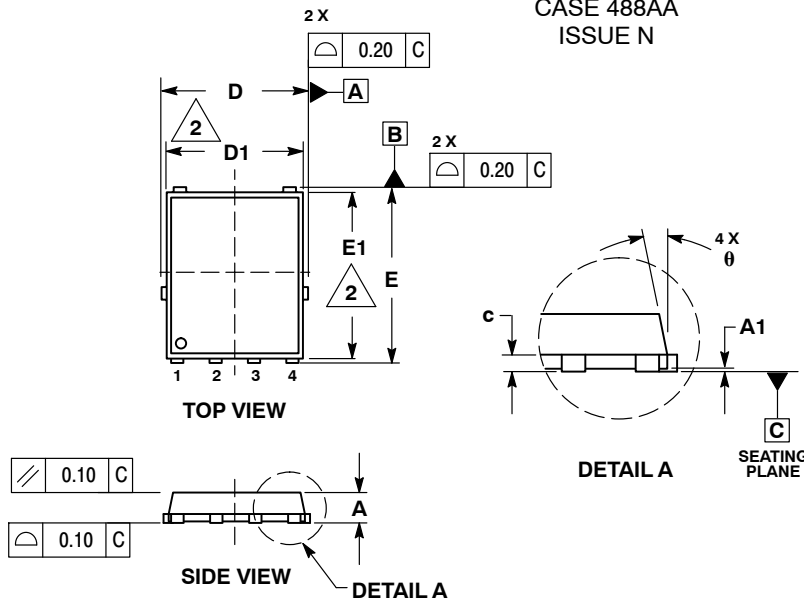

Figure 15. Transient Thermal Response

NTMFS6D2N08X

PACKAGE DIMENSIONS

DFN5 5x6, 1.27P
(SO-8FL)
CASE 488AA
ISSUE N



NOTES:

1. DIMENSIONING AND TOLERANCING PER ASME Y14.5M, 1994.
2. CONTROLLING DIMENSION: MILLIMETER.
3. DIMENSION D1 AND E1 DO NOT INCLUDE MOLD FLASH PROTRUSIONS OR GATE BURRS.

MILLIMETERS			
DIM	MIN	NOM	MAX
A	0.90	1.00	1.10
A1	0.00	---	0.05
b	0.33	0.41	0.51
c	0.23	0.28	0.33
D	5.00	5.15	5.30
D1	4.70	4.90	5.10
D2	3.80	4.00	4.20
E	6.00	6.15	6.30
E1	5.70	5.90	6.10
E2	3.45	3.65	3.85
e	1.27 BSC		
G	0.51	0.575	0.71
K	1.20	1.35	1.50
L	0.51	0.575	0.71
L1	0.125 REF		
M	3.00	3.40	3.80
θ	0 °	---	12 °

STYLE 1:

1. SOURCE
2. SOURCE
3. SOURCE
4. GATE
5. DRAIN

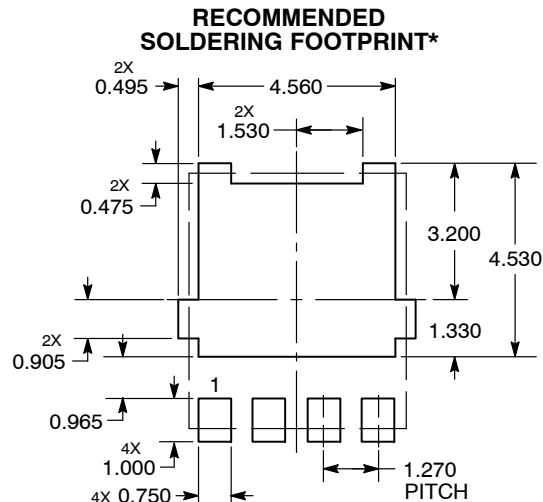
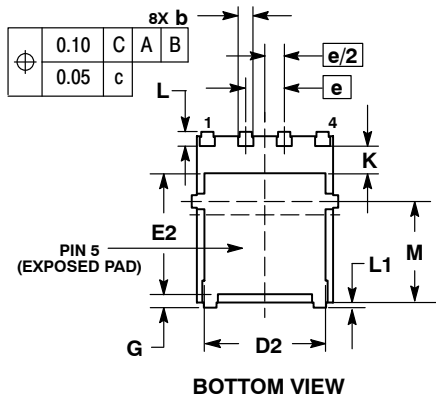

DIMENSIONS: MILLIMETERS

*For additional information on our Pb-Free strategy and soldering details, please download the **onsemi** Soldering and Mounting Techniques Reference Manual, SOLDERRM/D.

onsemi, **Onsemi**, and other names, marks, and brands are registered and/or common law trademarks of Semiconductor Components Industries, LLC dba "**onsemi**" or its affiliates and/or subsidiaries in the United States and/or other countries. **onsemi** owns the rights to a number of patents, trademarks, copyrights, trade secrets, and other intellectual property. A listing of **onsemi**'s product/patent coverage may be accessed at www.onsemi.com/site/pdf/Patent-Marking.pdf. **onsemi** reserves the right to make changes at any time to any products or information herein, without notice. The information herein is provided "as-is" and **onsemi** makes no warranty, representation or guarantee regarding the accuracy of the information, product features, availability, functionality, or suitability of its products for any particular purpose, nor does **onsemi** assume any liability arising out of the application or use of any product or circuit, and specifically disclaims any and all liability, including without limitation special, consequential or incidental damages. Buyer is responsible for its products and applications using **onsemi** products, including compliance with all laws, regulations and safety requirements or standards, regardless of any support or applications information provided by **onsemi**. "Typical" parameters which may be provided in **onsemi** data sheets and/or specifications can and do vary in different applications and actual performance may vary over time. All operating parameters, including "Typicals" must be validated for each customer application by customer's technical experts. **onsemi** does not convey any license under any of its intellectual property rights nor the rights of others. **onsemi** products are not designed, intended, or authorized for use as a critical component in life support systems or any FDA Class 3 medical devices or medical devices with a same or similar classification in a foreign jurisdiction or any devices intended for implantation in the human body. Should Buyer purchase or use **onsemi** products for any such unintended or unauthorized application, Buyer shall indemnify and hold **onsemi** and its officers, employees, subsidiaries, affiliates, and distributors harmless against all claims, costs, damages, and expenses, and reasonable attorney fees arising out of, directly or indirectly, any claim of personal injury or death associated with such unintended or unauthorized use, even if such claim alleges that **onsemi** was negligent regarding the design or manufacture of the part. **onsemi** is an Equal Opportunity/Affirmative Action Employer. This literature is subject to all applicable copyright laws and is not for resale in any manner.

ADDITIONAL INFORMATION

TECHNICAL PUBLICATIONS:

Technical Library: www.onsemi.com/design/resources/technical-documentation
onsemi Website: www.onsemi.com

ONLINE SUPPORT: www.onsemi.com/support

For additional information, please contact your local Sales Representative at www.onsemi.com/support/sales