

8 MHz, Rail-To-Rail, CMOS Operational Amplifier

NCS20161, NCS20162, NCS20164, NCV20161, NCV20162, NCV20164

The NCS20161, NCS20162, and NCS20164 are a family of single, dual and quad operational amplifiers (op amps) that provide 8 MHz gain-bandwidth product while consuming 500 μ A of quiescent current per channel. The NCS2016x has an input offset voltage of 0.3 mV and operates from 1.8 V to 5.5 V supply over a wide temperature range (-40°C to 125°C). The rail-to-rail input and output operation allows the use of the entire supply voltage range. Thus, this series of op amps offers superior performance over many industry standard parts. These devices are AEC-Q100 qualified when denoted by the NCV prefix.

With low current consumption and low supply voltage operation in industry standard packages, the NCS20161 series is ideal for sensor signal conditioning and low voltage current sensing applications in automotive, consumer and industrial markets.

Features

- Gain-Bandwidth Product: 8 MHz
- Low Supply Current per Channel: 500 μ A typ ($V_S = 5.5$ V)
- Low Input Offset Voltage: ± 0.3 mV
- Wide Supply Range: 1.8 V to 5.5 V
- Wide Temperature Range: -40°C to $+125^{\circ}\text{C}$
- Rail-to-Rail Input and Output
- Unity Gain Stable
- Available in Single, Dual and Quad Packages
- NCV Prefix for Automotive and Other Applications Requiring Unique Site and Control Change Requirements; AEC-Q100 Qualified and PPAP Capable
- These Devices are Pb-Free, Halogen Free/BFR Free and are RoHS Compliant

Applications

- Automotive
- Battery Powered / Portable
- Sensor Signal Conditioning
- Low Voltage Current Sensing
- Filter Circuits
- Unity Gain Buffer



SC70-5
CASE 419A



TSOP-5/SOT23-5
CASE 483



Micro8™/MSOP8
CASE 846A



SOIC-8
CASE 751

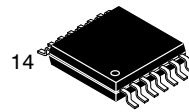

TSSOP-14
CASE 948G

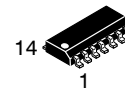

SOIC-14
CASE 751A

DEVICE MARKING INFORMATION

See general marking information in the device marking section on page 2 of this data sheet.

ORDERING INFORMATION

See detailed ordering and shipping information on page 3 of this data sheet.

This document contains information on some products that are still under development. onsemi reserves the right to change or discontinue these products without notice.

MARKING DIAGRAMS

Single Channel Configuration
NCS20161, NCV20161

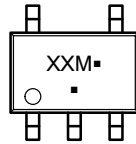

SC70-5
CASE 419A

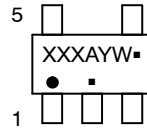

TSOP-5/SOT23-5
CASE 483

Dual Channel Configuration
NCS20162, NCV20162

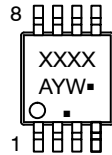

Micro8™/MSOP8
CASE 846A

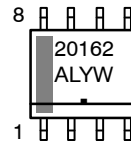

SOIC-8
CASE 751

Quad Channel Configuration
NCS20164, NCV20164

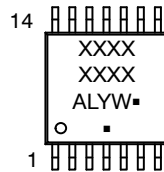

TSSOP-14
CASE 948G

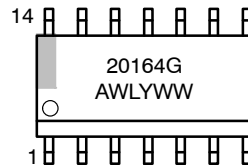

SOIC-14
CASE 751A

XXXXX = Specific Device Code
A = Assembly Location
WL, L = Wafer Lot
Y = Year
WW, W = Work Week
G or ■ = Pb-Free Package

(Note: Microdot may be in either location)

NCS20161, NCS20162, NCS20164, NCV20161, NCV20162, NCV20164

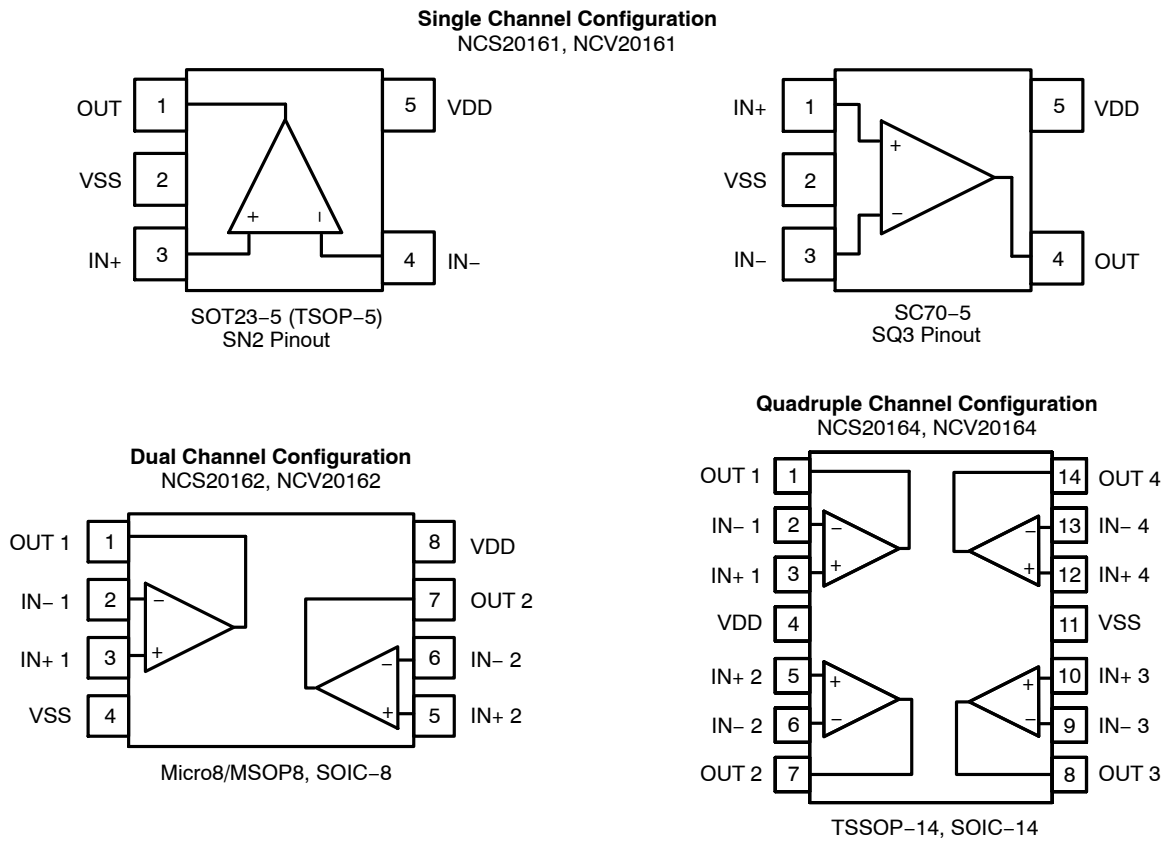

Figure 1. Pin Connections

ORDERING INFORMATION

| Device* | Configuration | Automotive | Marking | Package | Shipping† |
|------------------|---------------|------------|---------|----------------|----------------------|
| NCS20161SQ3T2G** | Single | No | TBD | SC70 | 3000 / Tape and Reel |
| NCS20161SN2T1G** | | | TBD | SOT23-5/TSOP-5 | 3000 / Tape and Reel |
| NCV20161SQ3T2G** | | Yes | TBD | SC70 | 3000 / Tape and Reel |
| NCV20161SN2T1G** | | | TBD | SOT23-5/TSOP-5 | 3000 / Tape and Reel |
| NCS20162DMR2G** | Dual | No | TBD | Micro8/MSOP8 | 4000 / Tape and Reel |
| NCS20162DR2G** | | | 20162 | SOIC-8 | 2500 / Tape and Reel |
| NCV20162DMR2G** | | Yes | TBD | Micro8/MSOP8 | 4000 / Tape and Reel |
| NCV20162DR2G** | | | 20162 | SOIC-8 | 2500 / Tape and Reel |
| NCS20164DR2G | Quad | No | 20164G | SOIC-14 | 2500 / Tape and Reel |
| NCS20164DTBR2G** | | | TBD | TSSOP-14 | 2500 / Tape and Reel |
| NCV20164DR2G** | | Yes | 20164G | SOIC-14 | 2500 / Tape and Reel |
| NCV20164DTBR2G** | | | TBD | TSSOP-14 | 2500 / Tape and Reel |

†For information on tape and reel specifications, including part orientation and tape sizes, please refer to our Tape and Reel Packaging Specifications Brochure, BRD8011/D.

*NCV Prefix for Automotive and Other Applications Requiring Unique Site and Control Change Requirements; AEC-Q100 Qualified and PPAP Capable.

**In Development. Contact local sales office for more information.

NCS20161, NCS20162, NCS20164, NCV20161, NCV20162, NCV20164

ABSOLUTE MAXIMUM RATINGS (Note 1)

| Rating | Symbol | Limit | Unit |
|--------------------------------------------------------|---------------------|----------------------------------|--------------------|
| Supply Voltage ($V_{DD} - V_{SS}$) | V_S | -0.3 to 6 | V |
| Common Mode Input Voltage | V_I | $V_{SS} - 0.3$ to $V_{DD} + 0.3$ | V |
| Differential Input Voltage | V_{ID} | $V_{DD} - V_{SS} + 0.2$ | V |
| Maximum Input Current | I_I | ± 10 | mA |
| Maximum Output Current (Note 2) | I_O | ± 100 | mA |
| Continuous Total Power Dissipation (Note 2) | P_D | 200 | mW |
| Maximum Junction Temperature | T_J | 150 | $^{\circ}\text{C}$ |
| Storage Temperature Range | T_{STG} | -65 to 150 | $^{\circ}\text{C}$ |
| Mounting Temperature (Infrared or Convection – 20 sec) | T_{mount} | 260 | $^{\circ}\text{C}$ |
| ESD Capability (Note 3) | Human Body Model | 2500 | V |
| | Charge Device Model | 1500 | |
| Latch-Up Current (Note 4) | I_{LU} | 100 | mA |
| Moisture Sensitivity Level (Note 5) | MSL | Level 1 | |

Stresses exceeding those listed in the Maximum Ratings table may damage the device. If any of these limits are exceeded, device functionality should not be assumed, damage may occur and reliability may be affected.

1. Refer to ELECTRICAL CHARACTERISTICS for Safe Operating Area.
2. Continuous short circuit operation to ground at elevated ambient temperature can result in exceeding the maximum allowed junction temperature of 150 $^{\circ}\text{C}$. Output currents in excess of the maximum output current rating over the long term may adversely affect reliability. Shorting output to either VDD or VSS will adversely affect reliability.
3. This device series incorporates ESD protection and is tested by the following methods:
 ESD Human Body Model tested per JEDEC standard Js-001-2017 (AEC-Q100-002)
 ESD Charged Device Model tested per JEDEC standard JS-002-2014 (AEC-Q100-011)
4. Latch-up Current tested per JEDEC standard JESD78E (AEC-Q100-004)
5. Moisture Sensitivity Level tested per IPC/JEDEC standard: J-STD-020A

OPERATING RANGES

| Parameter | Symbol | Min | Max | Unit |
|------------------------------------------------|----------|----------------|----------------|--------------------|
| Operating Supply Voltage ($V_{DD} - V_{SS}$) | V_S | 1.8 | 5.5 | V |
| Differential Input Voltage | V_{ID} | - | V_S | V |
| Common Mode Input Voltage Range | V_{CM} | $V_{SS} - 0.1$ | $V_{DD} + 0.1$ | V |
| Ambient Temperature | T_A | -40 | 125 | $^{\circ}\text{C}$ |

Functional operation above the stresses listed in the Recommended Operating Ranges is not implied. Extended exposure to stresses beyond the Recommended Operating Ranges limits may affect device reliability.

THERMAL CHARACTERISTICS (Note 6)

| Package | Junction-to-Ambient Thermal Resistance θ_{JA} | Junction-to-Case Top Thermal Resistance Ψ_{JT} | Junction-to-Board Thermal Resistance Ψ_{JB} | Unit |
|---------|---------------------------------------------------------|--------------------------------------------------------|-----------------------------------------------------|-----------------------------|
| SOIC-8 | 205 | 32 | 116 | $^{\circ}\text{C}/\text{W}$ |
| SOIC-14 | 138 | 8 | 100 | $^{\circ}\text{C}/\text{W}$ |

6. Thermal parameters are based on a 2s2p board following JESD51-7 (JEDEC).

NCS20161, NCS20162, NCS20164, NCV20161, NCV20162, NCV20164

ELECTRICAL CHARACTERISTICS AT $V_S = 1.8\text{ V to }5.5\text{ V}$

$T_A = 25^\circ\text{C}$; $R_L \geq 10\text{ k}\Omega$ connected to mid-supply; $V_{CM} = V_{OUT} = \text{mid-supply}$ unless otherwise noted.
 Boldface limits apply over the specified temperature range, $T_A = -40^\circ\text{C}$ to 125°C . (Note 7)

| Parameter | Symbol | Conditions | Min | Typ | Max | Unit |
|-------------------------------|--------------|------------------------------------------------------------------------------------|-----------|-----------------------------|-----------------------------|------------------------------|
| INPUT CHARACTERISTICS | | | | | | |
| Input Offset Voltage | V_{OS} | $V_S = 5\text{ V}$ | - | ± 0.3 | ± 2.1 | mV |
| | | $V_S = 5\text{ V}$ | - | - | ± 2.6 | mV |
| Offset Voltage Drift | dV_{OS}/dT | $V_S = 5\text{ V}$ | - | ± 1.5 | - | $\mu\text{V}/^\circ\text{C}$ |
| Input Bias Current (Note 7) | I_{IB} | | - | ± 5 | - | pA |
| Input Offset Current (Note 7) | I_{OS} | | - | ± 5 | - | pA |
| Channel Separation | | DC | - | 100 | - | dB |
| Input Capacitance | C_{IN} | | - | 4 | - | pF |
| Common Mode Rejection Ratio | CMRR | $V_S = 5.5\text{ V}$, $V_{CM} = V_{SS} - 0.1\text{ V}$ to $V_{DD} - 1.4\text{ V}$ | 80 | 103 | - | dB |
| | | $V_S = 5.5\text{ V}$, $V_{CM} = -0.1\text{ V}$ to 5.6 V | 57 | 79 | - | |
| | | $V_S = 1.8\text{ V}$, $V_{CM} = V_{SS} - 0.1\text{ V}$ to $V_{DD} - 1.4\text{ V}$ | - | 91 | - | |
| | | $V_S = 1.8\text{ V}$, $V_{CM} = -0.1\text{ V}$ to 1.9 V | - | 71 | - | |

OUTPUT CHARACTERISTICS

| | | | | | | |
|------------------------------------|-------------------|------------------------------------------------------------------------------------------------------------|-----|-----|----|----|
| Open Loop Voltage Gain | A_{VOL} | $V_S = 1.8\text{ V}$, $V_{SS} + 0.04\text{ V} < V_O < V_{DD} - 0.04\text{ V}$, $R_L = 10\text{ k}\Omega$ | - | 100 | - | dB |
| | | $V_S = 5.5\text{ V}$, $V_{SS} + 0.05\text{ V} < V_O < V_{DD} - 0.05\text{ V}$, $R_L = 10\text{ k}\Omega$ | 101 | 108 | - | |
| | | $V_S = 1.8\text{ V}$, $V_{SS} + 0.06\text{ V} < V_O < V_{DD} - 0.06\text{ V}$, $R_L = 2\text{ k}\Omega$ | - | 97 | - | |
| | | $V_S = 5.5\text{ V}$, $V_{SS} + 0.15\text{ V} < V_O < V_{DD} - 0.15\text{ V}$, $R_L = 2\text{ k}\Omega$ | - | 113 | - | |
| Short Circuit Current | I_{SC} | Output sourcing current $V_S = 5\text{ V}$ | - | 40 | - | mA |
| | | Output sinking current, $V_S = 5\text{ V}$ | - | 50 | - | |
| Output Voltage Swing from V_{DD} | $V_{DD} - V_{OH}$ | $V_S = 5.5\text{ V}$, $R_L = 10\text{ k}\Omega$ | - | 3 | 20 | mV |
| | | $V_S = 5.5\text{ V}$, $R_L = 2\text{ k}\Omega$ | - | - | 60 | |
| Output Voltage Swing from V_{SS} | $V_{OL} - V_{SS}$ | $V_S = 5.5\text{ V}$, $R_L = 10\text{ k}\Omega$ | - | 3 | 20 | mV |
| | | $V_S = 5.5\text{ V}$, $R_L = 2\text{ k}\Omega$ | - | - | 60 | |

AC CHARACTERISTICS

| | | | | | | |
|----------------------------|----------|-----------------------------------------------------------------------------------|---|-----|---|------------------------|
| Unity Gain Bandwidth | UGBW | $V_S = 5\text{ V}$, $G = +1$ | - | 8 | - | MHz |
| Slew Rate at Unity Gain | SR | $V_S = 5\text{ V}$, $G = +1$ | - | 3.5 | - | $\text{V}/\mu\text{s}$ |
| Phase Margin | Φ_m | $V_S = 5\text{ V}$, $G = +1$ | - | 52 | - | $^\circ$ |
| Gain Margin | A_m | | - | 11 | - | dB |
| Settling Time to 0.1% | t_S | $V_S = 5\text{ V}$, $V_{IN} = 2\text{ V}$ step, $G = +1$, $C_L = 100\text{ pF}$ | - | 0.5 | - | μs |
| Settling Time to 0.01% | t_S | $V_S = 5\text{ V}$, $V_{IN} = 2\text{ V}$ step, $G = +1$, $C_L = 100\text{ pF}$ | - | 1 | - | μs |
| Overload Recovery Time | t_{OR} | $V_S = 5\text{ V}$, $V_{IN} \times \text{gain} > V_S$ | - | 1 | - | μs |
| Open Loop Output Impedance | Z_{OL} | $V_S = 5\text{ V}$, $f = 10\text{ MHz}$ | - | 240 | - | Ω |

NOISE CHARACTERISTICS

| | | | | | | |
|--------------------------------------|-------|-----------------------------------------------------------------------------------------------------------|---|--------|---|------------------------------|
| Total Harmonic Distortion plus Noise | THD+n | $V_S = 5.5\text{ V}$, $V_{CM} = 2.5\text{ V}$, $V_O = 1\text{ V}_{RMS}$, $G = +1$, $f = 1\text{ kHz}$ | - | 0.0008 | - | % |
| Input Referred Voltage Noise | e_n | $V_S = 5\text{ V}$, $f = 1\text{ kHz}$ | - | 20 | - | $\text{nV}/\sqrt{\text{Hz}}$ |
| | | $V_S = 5\text{ V}$, $f = 10\text{ kHz}$ | - | 10 | - | |

7. Performance guaranteed over the indicated operating temperature range by design and/or characterization.

NCS20161, NCS20162, NCS20164, NCV20161, NCV20162, NCV20164

ELECTRICAL CHARACTERISTICS AT $V_S = 1.8\text{ V to }5.5\text{ V}$ (continued)

$T_A = 25^\circ\text{C}$; $R_L \geq 10\text{ k}\Omega$ connected to mid-supply; $V_{CM} = V_{OUT} = \text{mid-supply}$ unless otherwise noted.
 Boldface limits apply over the specified temperature range, $T_A = -40^\circ\text{C}$ to 125°C . (Note 7)

| Parameter | Symbol | Conditions | Min | Typ | Max | Unit |
|-----------|--------|------------|-----|-----|-----|------|
|-----------|--------|------------|-----|-----|-----|------|

NOISE CHARACTERISTICS

| | | | | | | |
|-----------------------------------|-------|------------------------------------------|---|----|---|------------------------|
| Input Referred Current Noise | i_n | f = 1 kHz | – | 20 | – | fA/ $\sqrt{\text{Hz}}$ |
| Input Voltage Noise, Peak-to-Peak | E_n | $V_S = 5\text{ V}$, f = 0.1 Hz to 10 Hz | – | 5 | – | μVPP |

SUPPLY CHARACTERISTICS

| | | | | | | |
|--------------------------------|----------------|-------------------------------------------------------------------|---|-----|------------|-----------------|
| Power Supply Rejection Ratio | PSRR | V _S = 1.8 V – 5.5 V, V _{CM} = V _{SS} | – | 8 | 80 | $\mu\text{V/V}$ |
| Power Supply Quiescent Current | I _Q | Per channel, no load | – | 500 | 800 | μA |

7. Performance guaranteed over the indicated operating temperature range by design and/or characterization.

TYPICAL CHARACTERISTICS

(AT $T_A = 25^\circ\text{C}$, $V_{CM} = \text{MID-SUPPLY}$, $C_L = 20 \text{ PF}$, $R_L = 10 \text{ K}\Omega$ TO MID-SUPPLY, UNLESS OTHERWISE NOTED)

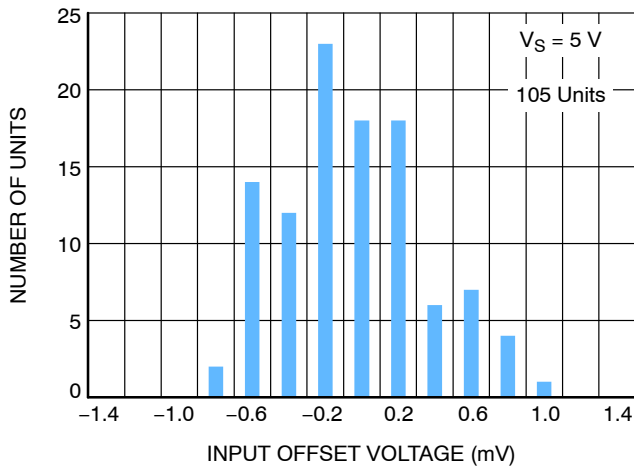

Figure 2. Input Offset Voltage Distribution

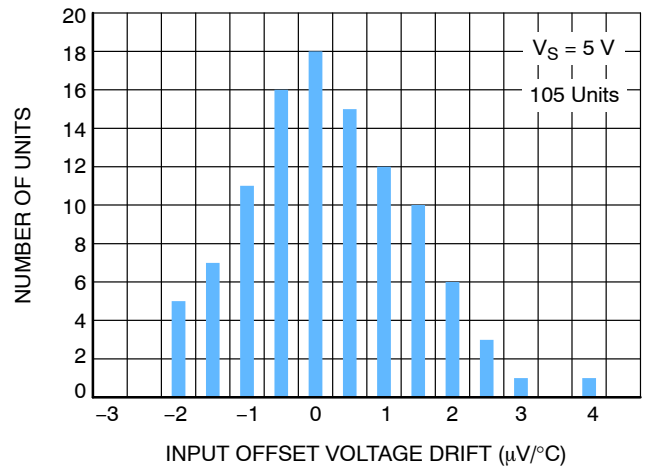

Figure 3. Input Offset Voltage Drift Distribution

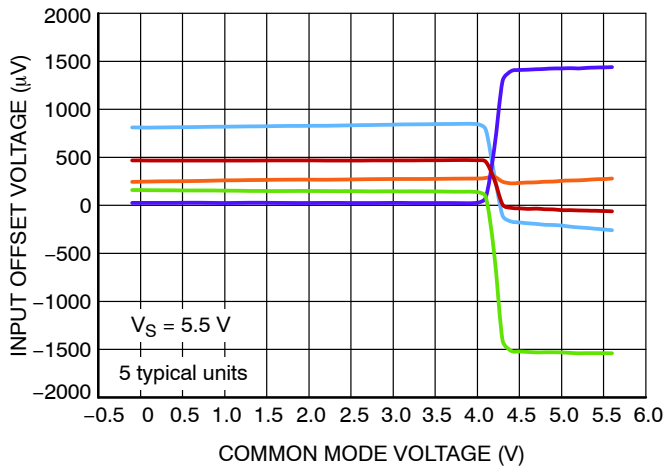

Figure 4. Input Offset Voltage vs. Common Mode Voltage at 5.5 V Supply

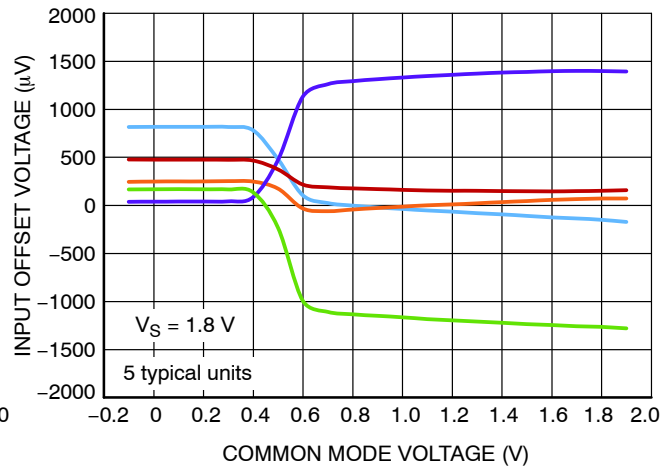

Figure 5. Input Offset Voltage vs. Common Mode Voltage at 1.8 V Supply

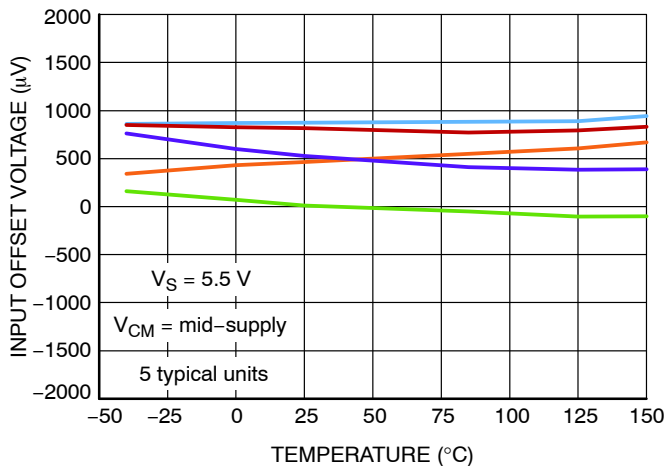

Figure 6. Input Offset Voltage vs. Temperature at 5.5 V Supply

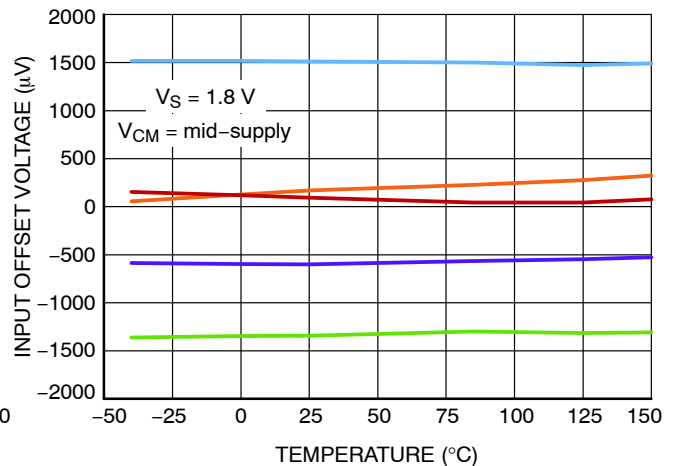

Figure 7. Input Offset Voltage vs. Temperature at 1.8 V Supply

TYPICAL CHARACTERISTICS

(AT $T_A = 25^\circ\text{C}$, $V_{CM} = \text{MID-SUPPLY}$, $C_L = 20 \text{ PF}$, $R_L = 10 \text{ K}\Omega$ TO MID-SUPPLY, UNLESS OTHERWISE NOTED)

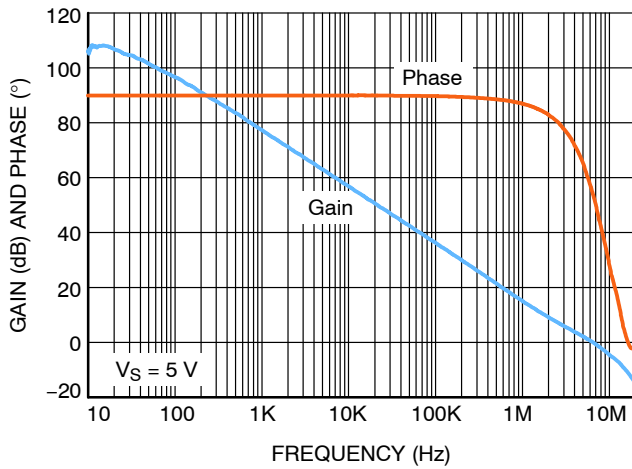

Figure 8. Open Loop Gain vs. Frequency

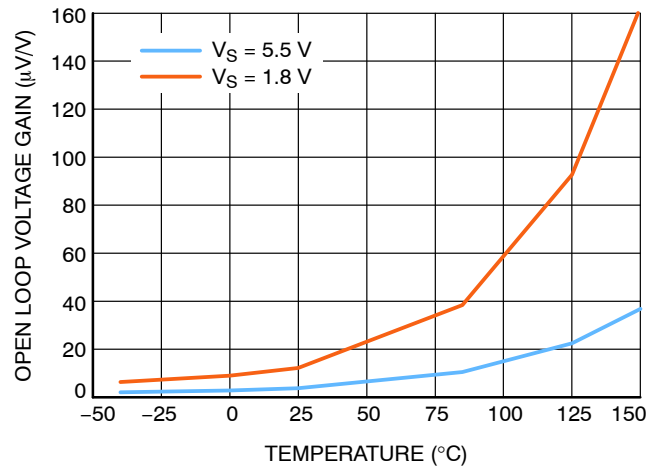

Figure 9. Open Loop Gain vs. Temperature

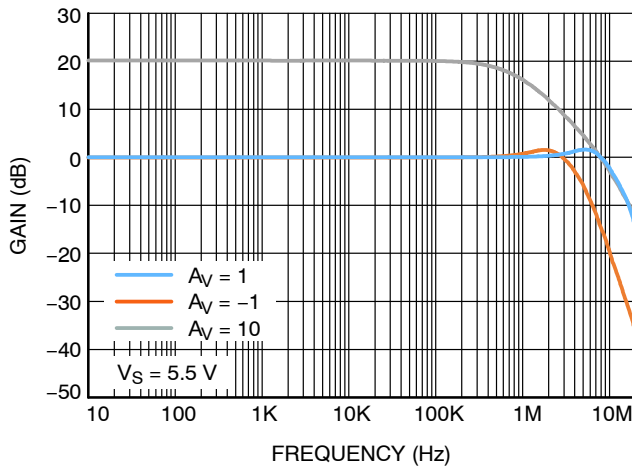

Figure 10. Closed Loop Gain vs. Frequency

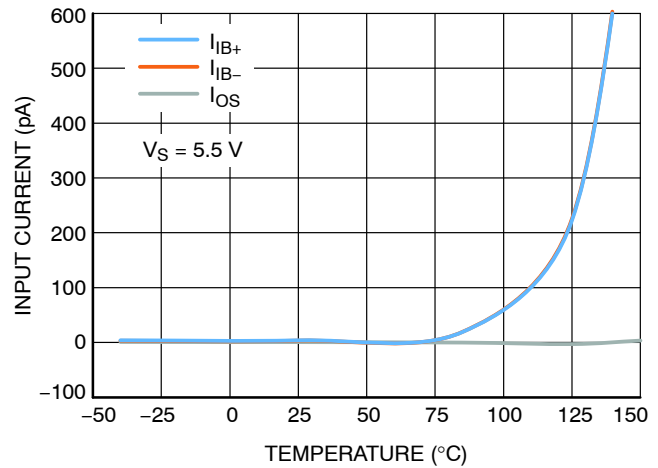

Figure 11. Input Current vs. Temperature

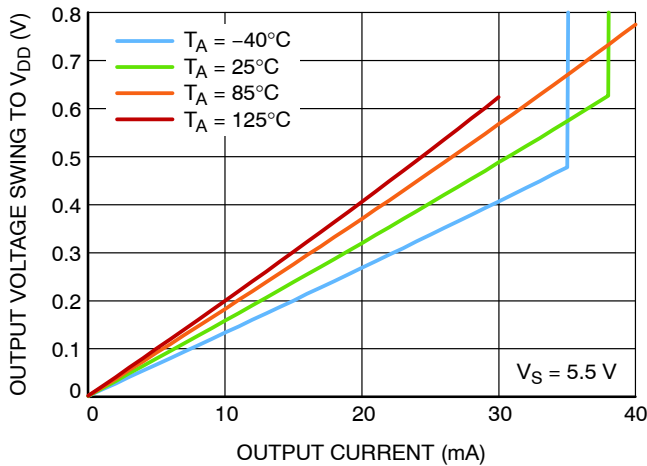

Figure 12. Output Voltage Swing High

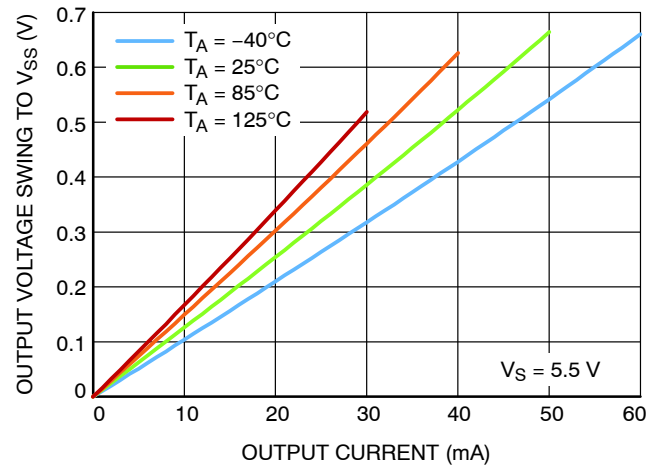

Figure 13. Output Voltage Swing Low

TYPICAL CHARACTERISTICS

(AT $T_A = 25^\circ\text{C}$, $V_{CM} = \text{MID-SUPPLY}$, $C_L = 20 \text{ PF}$, $R_L = 10 \text{ K}\Omega$ TO MID-SUPPLY, UNLESS OTHERWISE NOTED)

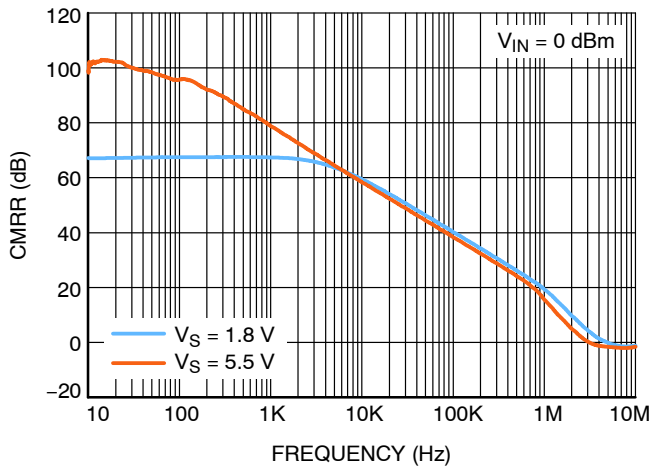

Figure 14. CMRR vs Frequency

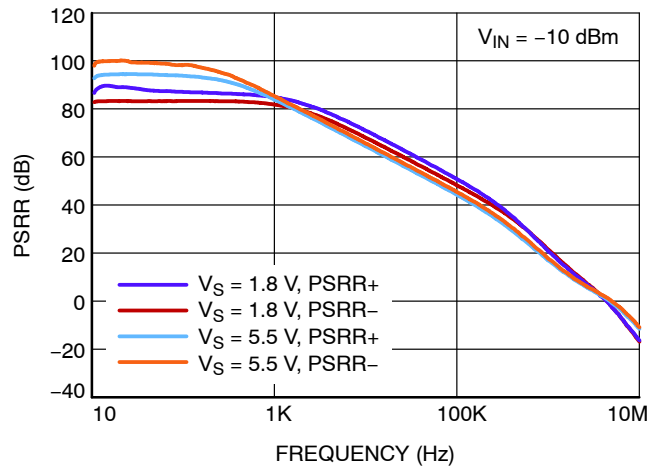

Figure 15. PSRR vs. Frequency

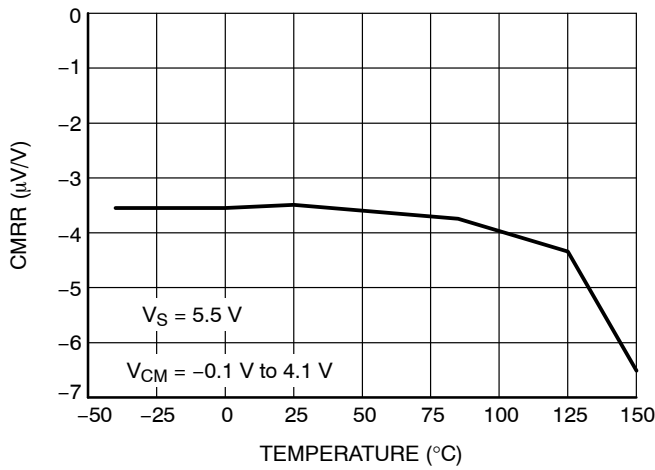

Figure 16. CMRR vs Temperature

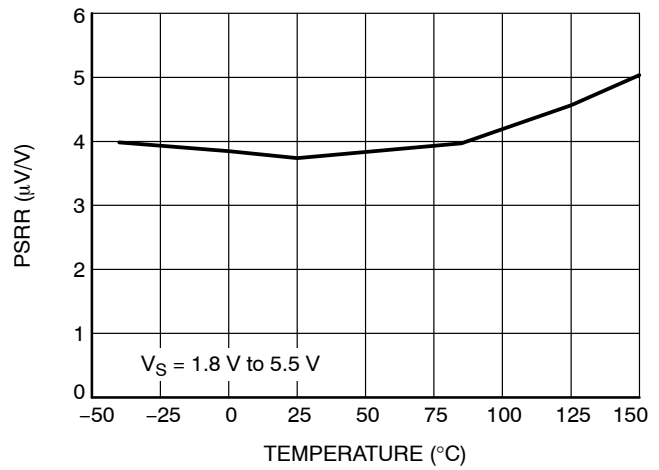

Figure 17. PSRR vs. Temperature

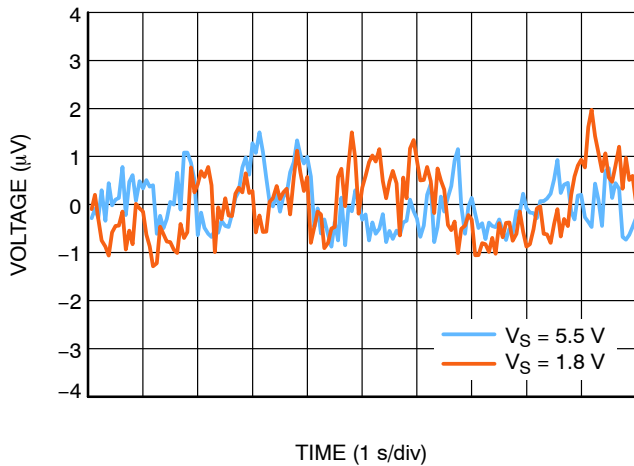

Figure 18. 0.1 Hz to 10 Hz Noise

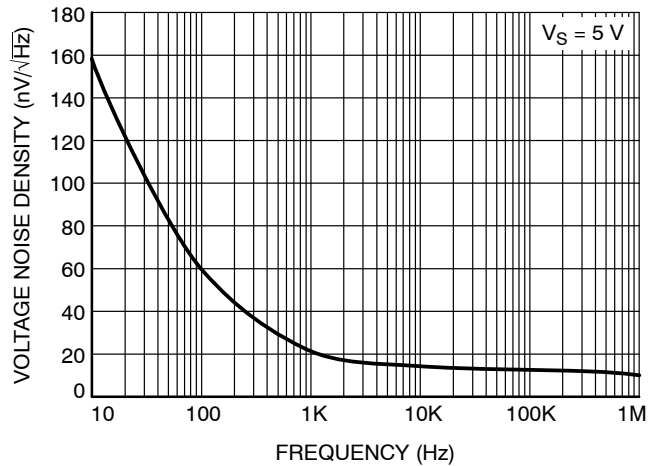

Figure 19. Voltage Noise Density vs. Frequency

TYPICAL CHARACTERISTICS

(AT $T_A = 25^\circ\text{C}$, $V_{CM} = \text{MID-SUPPLY}$, $C_L = 20 \text{ PF}$, $R_L = 10 \text{ K}\Omega$ TO MID-SUPPLY, UNLESS OTHERWISE NOTED)

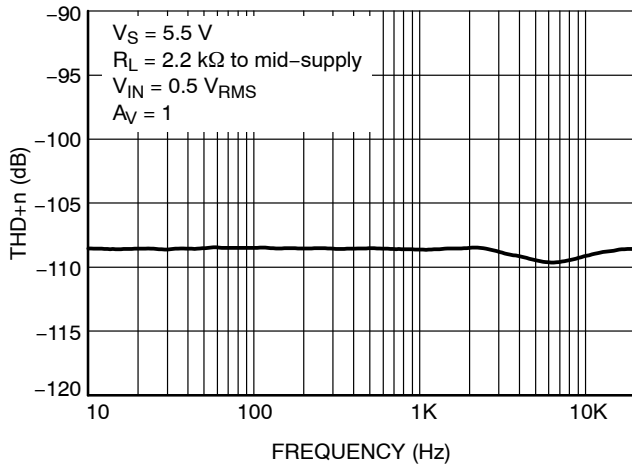

Figure 20. THD+n vs. Frequency

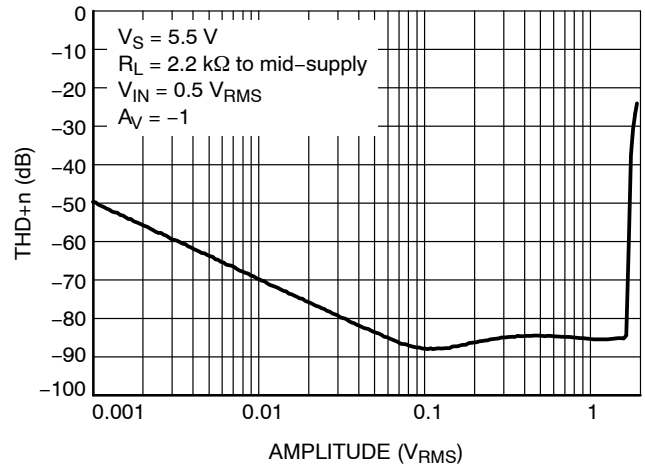

Figure 21. THD+n vs. Output Amplitude

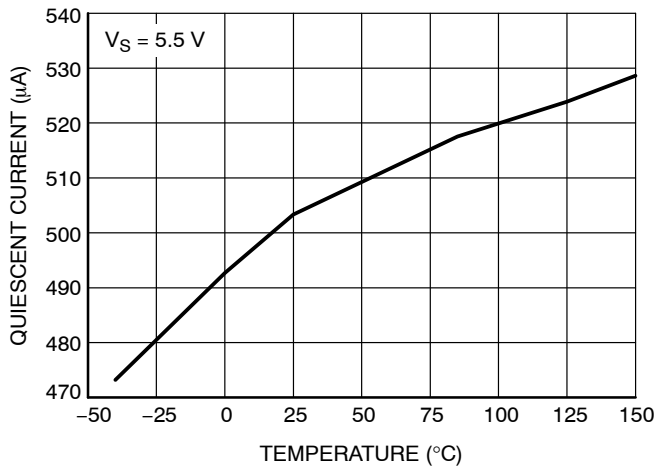

Figure 22. Quiescent Current Per Channel vs. Temperature

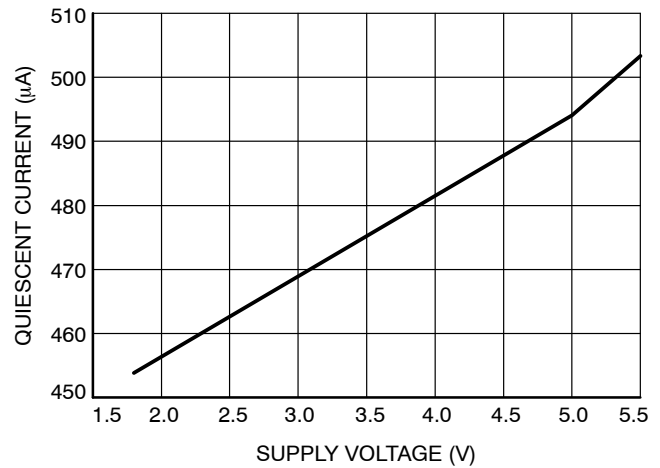

Figure 23. Quiescent Current Per Channel vs. Supply Voltage

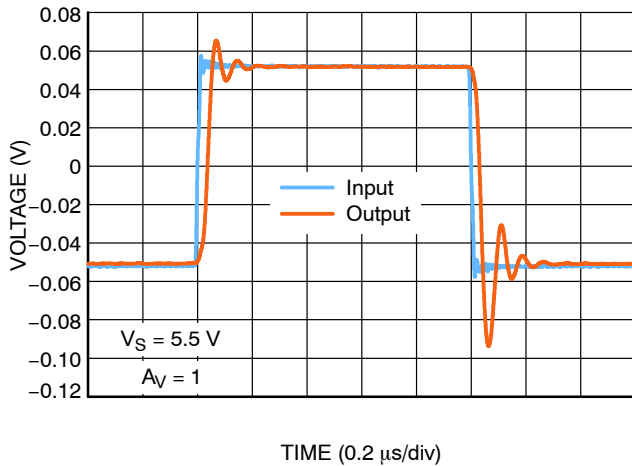

Figure 24. Small Signal Step Response

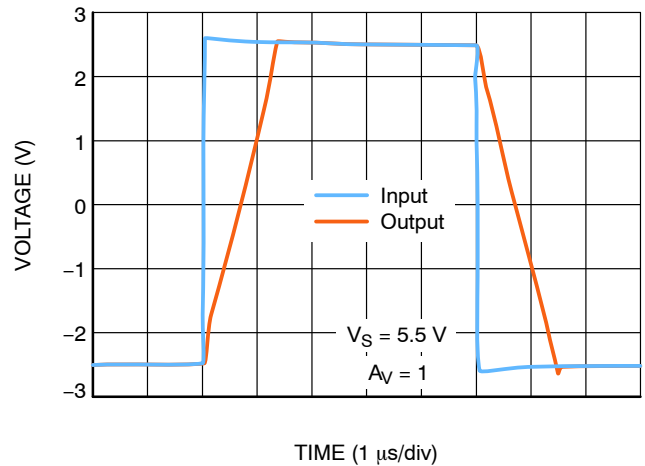

Figure 25. Large Signal Step Response

TYPICAL CHARACTERISTICS

(AT $T_A = 25^\circ\text{C}$, $V_{CM} = \text{MID-SUPPLY}$, $C_L = 20 \text{ PF}$, $R_L = 10 \text{ K}\Omega$ TO MID-SUPPLY, UNLESS OTHERWISE NOTED)

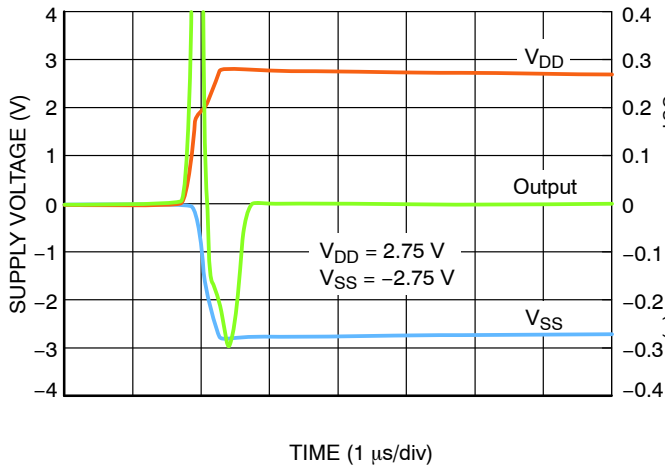

Figure 26. Power Up

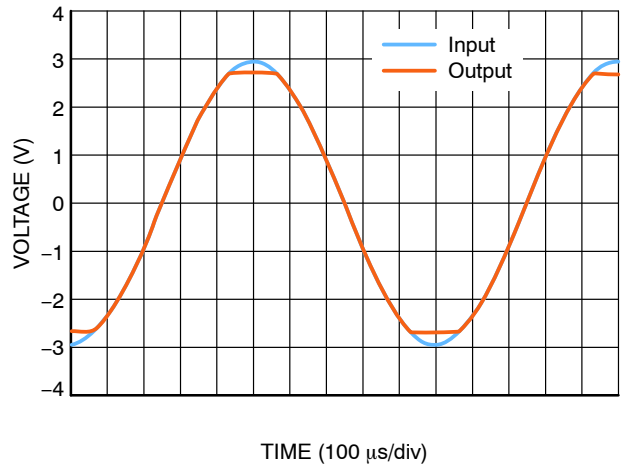

Figure 27. No Phase Reversal

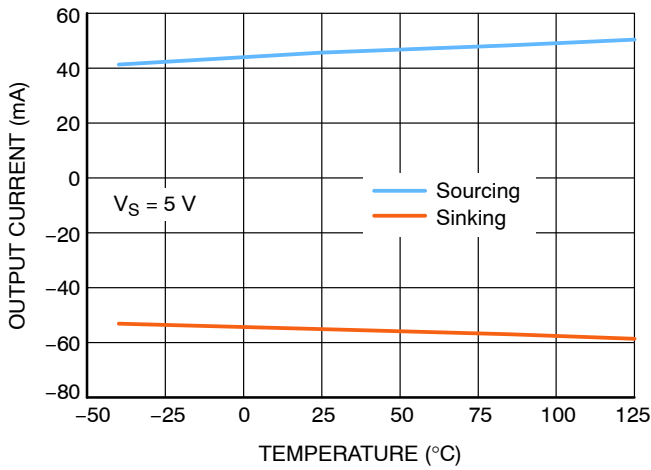

Figure 28. Short Circuit Current vs. Temperature

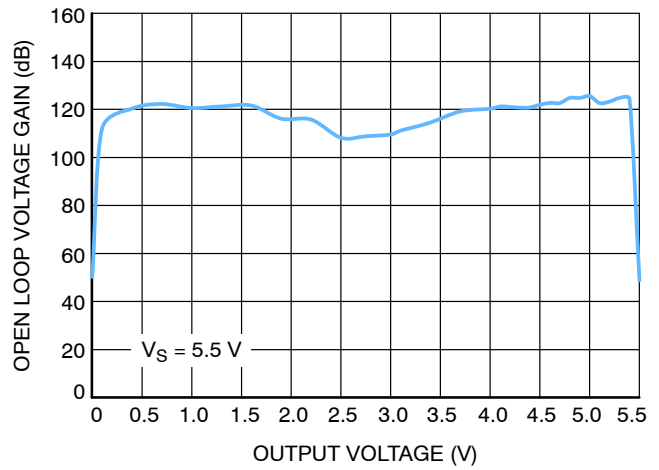

Figure 29. Open Loop Gain vs. Output Voltage

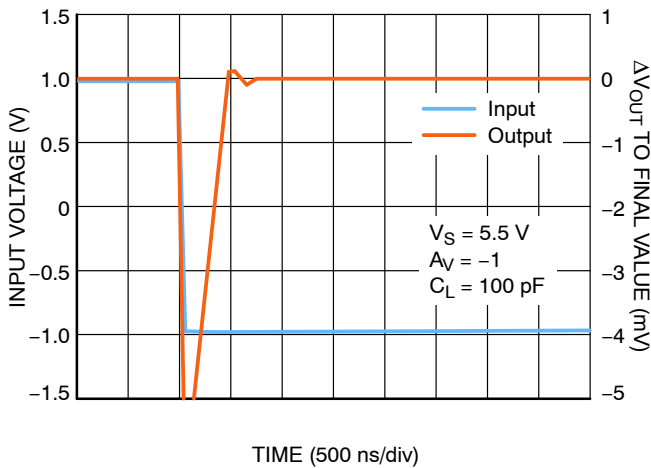

Figure 30. Output Low-to-High Settling Time

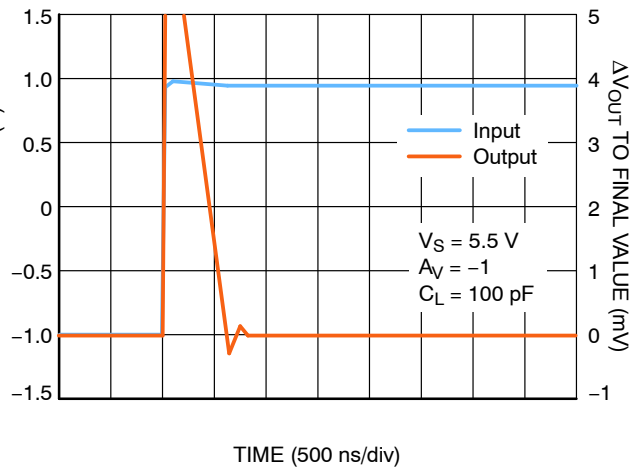

Figure 31. Output High-to-Low Settling Time

TYPICAL CHARACTERISTICS

(AT $T_A = 25^\circ\text{C}$, $V_{CM} = \text{MID-SUPPLY}$, $C_L = 20 \text{ PF}$, $R_L = 10 \text{ K}\Omega$ TO MID-SUPPLY, UNLESS OTHERWISE NOTED)

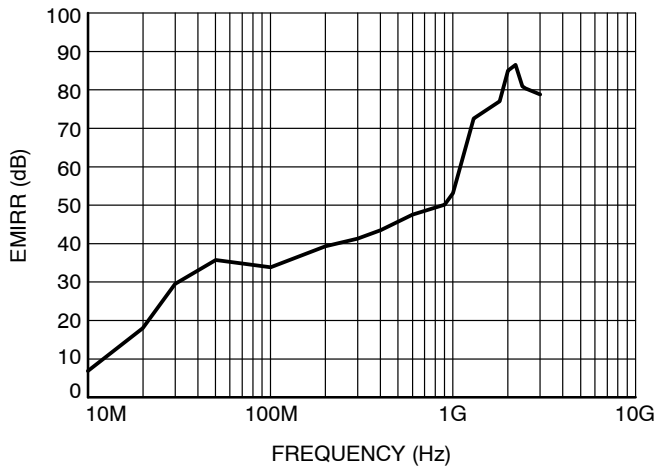

Figure 32. EMIRR vs. Frequency

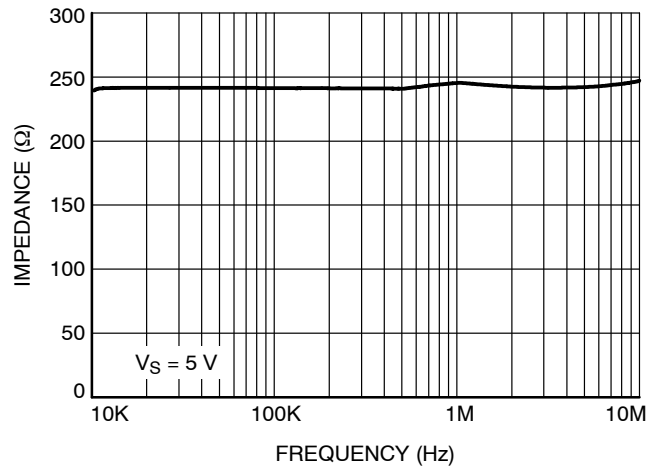

Figure 33. Open Loop Output Impedance vs. Frequency

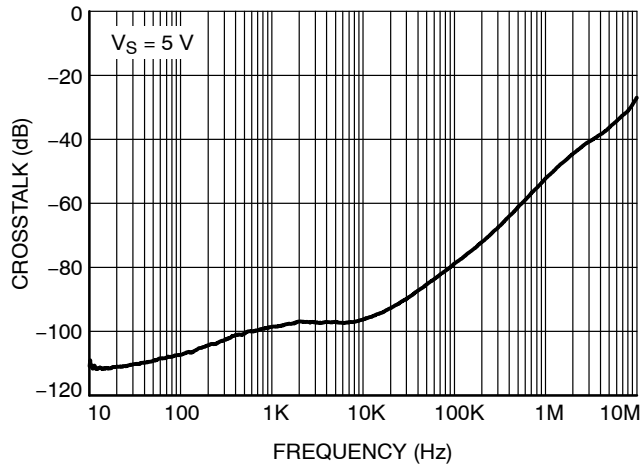

Figure 34. Channel Separation vs. Frequency

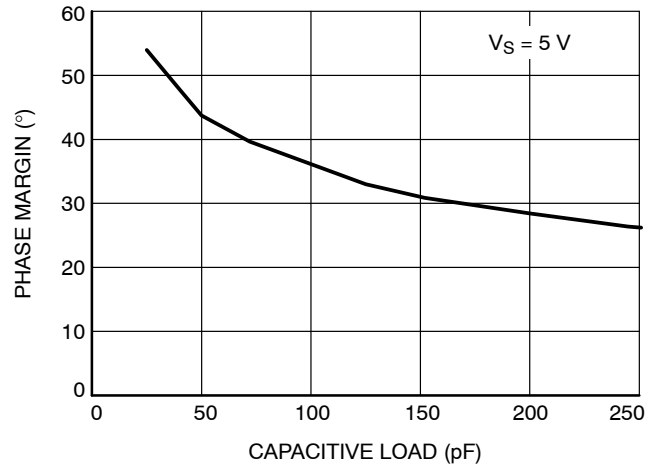

Figure 35. Phase Margin vs. Capacitive Load

TYPICAL CHARACTERISTICS

(AT $T_A = 25^\circ\text{C}$, $V_{CM} = \text{MID-SUPPLY}$, $C_L = 20 \text{ pF}$, $R_L = 10 \text{ k}\Omega$ TO MID-SUPPLY, UNLESS OTHERWISE NOTED)

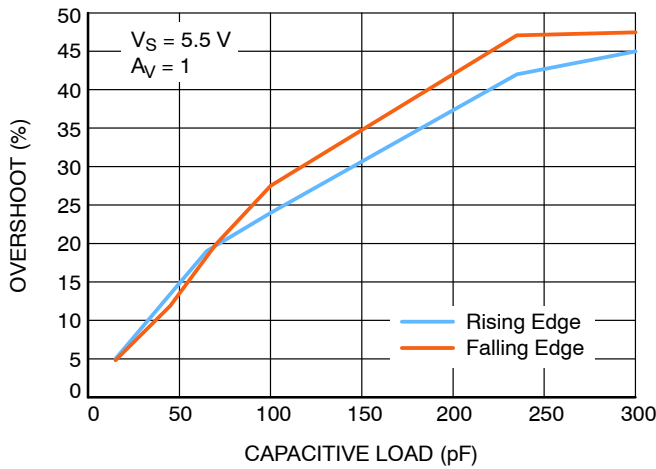

Figure 36. Overshoot vs. Capacitive Load for $A_V = 1$

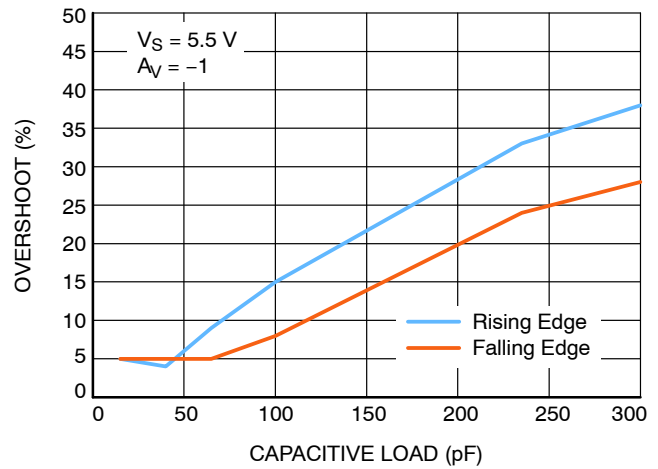

Figure 37. Overshoot vs. Capacitive Load for $A_V = -1$

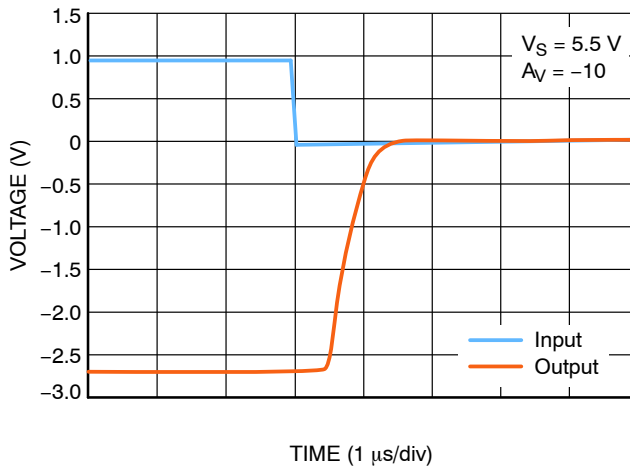

Figure 38. Negative Overvoltage Recovery

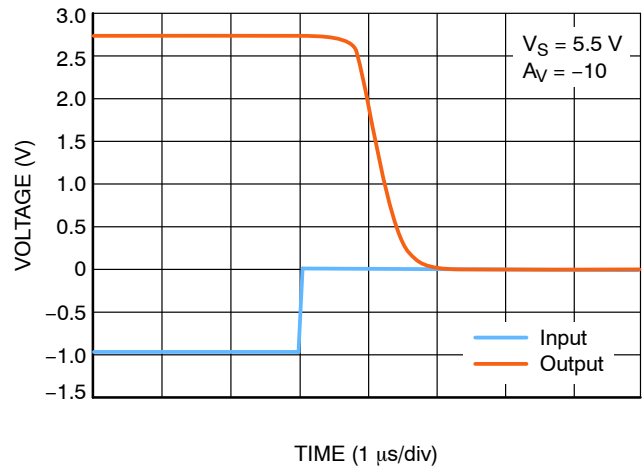

Figure 39. Positive Overvoltage Recovery

APPLICATION INFORMATION

The NCS20161 family of operational amplifiers is manufactured using onsemi’s CMOS process. Products in this class are general purpose, unity-gain stable amplifiers and include single, dual and quad configurations.

Rail-to-Rail Input with No Phase Reversal

The NCS2016x operational amplifiers are designed to prevent phase reversal or any similar issues when the input pins potential exceed the supply voltages by up to 100 mV.

The input stage of the NCS20161 family consists of two differential CMOS input stages connected in parallel: the first is constructed using paired PMOS devices and it operates at low common mode input voltages (V_{CM}); the second stage is build using paired NMOS devices to operate at high V_{CM} . The transition between the two input stages occurs at a common mode input voltage of approximately $V_{DD}-1.3V$.

Limiting Input Voltages

In order to prevent damage and/or improper operation of these amplifiers, the application circuit must never expose the input pins to voltages or currents higher than the Absolute Maximum Ratings.

The internal ESD structure includes special diodes to protect the input stages while maintaining a low input bias current (I_{IB}). The input protection circuitry clamp the inputs when the signals applied exceed more than one diode drop below V_{SS} or one diode drop above V_{DD} . Very fast ESD

events (within the limits specified) trigger the protection structure so the operational amplifier is not damaged.

In order to safe guard against excessive voltages across the op amp’s inputs, external clamp diodes can be used as shown in Figure 40. The four low-drop fast diodes (Schottky preferred) are used in parallel with the internal structure to divert the excessive energy to the supply rails where it can be easily dissipated or absorbed by the supply capacitors. The application designer should also take into account that these external diodes add leakage currents and parasitic capacitance that must be considered when evaluating the end-to-end performance of the amplifier stage.

Limiting Input Currents

In order to prevent damage/ improper operation of these amplifiers, the application circuit must limit the current flowing through the input pins. A possible solution is presented in Figure 40 by means of the two added series resistors. The minimum value for the input resistors should be calculated using Ohm’s Law so they limit the input pin current to less than the absolute maximum values specified. The application designer should take into account that these resistors also add parasitic inductance that must be considered when evaluating performance.

Combining the current limiting resistors with the voltage limiting diodes creates a solid input protection structure, that can be used to insure reliable operation of the amplifier even in the hardest conditions.

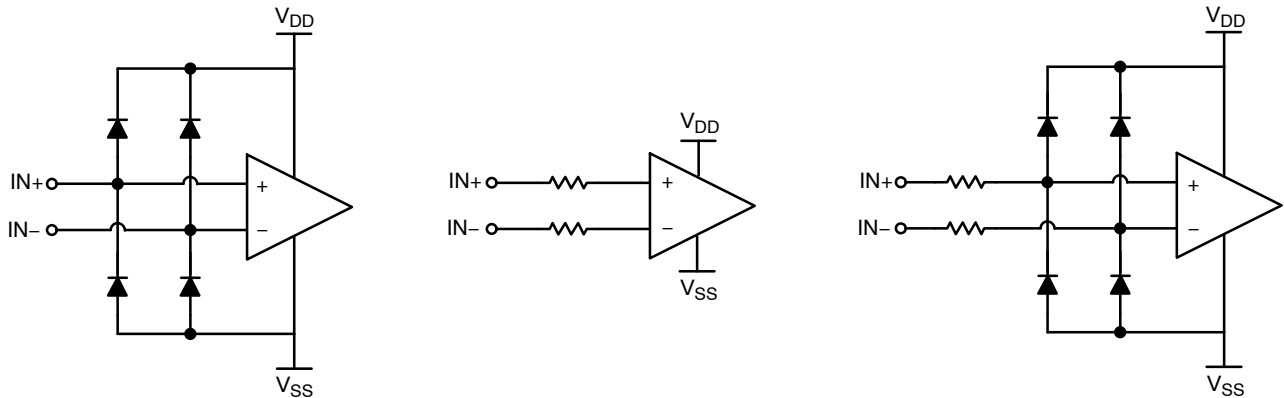

Figure 40. Typical Protection of the Operational Amplifier Inputs

Rail-to-Rail Output

The maximum output voltage swing is dependent of the particular output load. According to the specification, the output can reach within 20 mV of either supply rail when load resistance is 10 kΩ. The V_{OL} and V_{OH} graphs shows the load drive capabilities of the part under different conditions. Output current is internally limited to the typical values listed in the Electrical Characteristics table.

Capacitive Loads

Driving capacitive loads can create stability problems for voltage feedback op amps, as it is a known possible cause for:

- ◆ degraded phase margin
- ◆ lowered bandwidth
- ◆ gain peaking of the frequency response
- ◆ overshoot and ringing of the step response

While the NCS2016x series op amps are capable of driving capacitive loads up to 100 pF, adding a small resistor in series to the output (R_{ISO} in Figure 41) will increase the phase margin. This leads to higher stability by making the equivalent load more resistive at high frequencies.

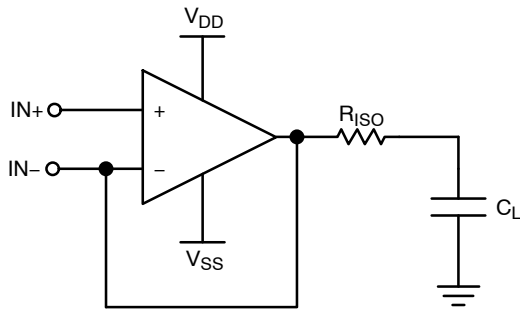

Figure 41. Driving Capacitive Loads

Simulating the application with onsemi’s Spice model is a good starting point for selecting the isolation resistor’s value. Bench testing the frequency and step response can be used to fine-tune the value according to the desired characteristic.

Unity Gain Bandwidth

Interfacing a high impedance sensor’s output to a relatively low-impedance ADC input usually requires an intermediate stage to avoid unwanted interference of the two devices, and this stage needs to have a high input impedance, a low output impedance, and high output current.

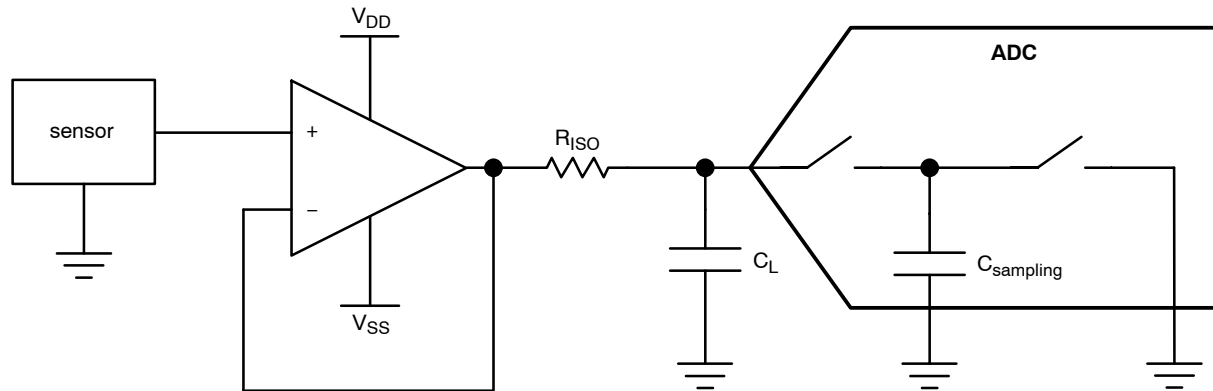

Figure 42. Unity Gain Buffer Stage for Sampling with ADC

Power Supply Bypassing

For AC, the power supply pins (VDD and VSS for split supply, VDD for single supply) should be bypassed locally with a quality capacitor in the range of 100 nF as close as possible to the amplifier supply pins. Ceramic capacitors are recommended for their low ESR and good high frequency response.

For DC, a bulk capacitor in the range of 1 μF placed within inches distance from the op amp can provide the additional current needed to drive higher loads.

Unused Operational Amplifiers

Occasionally not all the op amp channels offered in the quad packages are needed for a specific application. They can be connected as “buffering ground” as shown in Figure 43, a solution that does not need any extra parts. Connecting them differently (inputs split to rails, left floating, etc.) can sometimes cause unwanted oscillation,

The unity gain buffer is recommended here (Figure 42). The ADC’s internal sampling capacitor requires a buffer front-end to recharge it faster than the sampling time, and this problem is even worse if more channels are sampled by the same ADC using an internal multiplexer. In order to achieve a settling time shorter than the multiplexed sampling rate, an RC stage is recommended between the buffer and the ADC input. The RISO resistor’s value should be low enough to charge the capacitor quickly, but at the same time large enough to isolate the capacitive load from the amplifier output to preserve phase margin. When transients are generated by the sensor’s output, first the two amplifier inputs see a high differential voltage between them, then the output settles and brings the inverting input back to the correct voltage.

Let us take an example of a 0.1 V to 4 V sensor signal. To successfully accommodate it, the differential input range of the NCS2016x is close to the supply range and the output will match the input. The differential input voltage is limited only by the ESD protection structure and not by back-to-back diodes between inputs.

crosstalk, increased current consumption, or add noise to the supply rails.

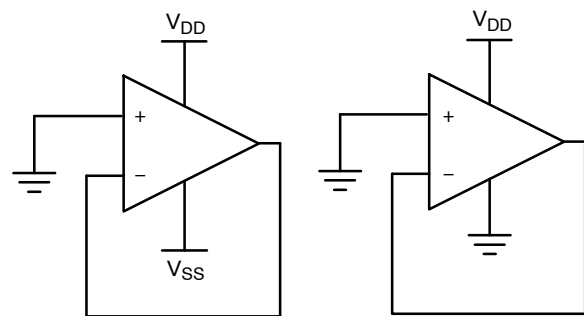

Figure 43. Unused Operational Amplifiers

PCB Surface Leakage

If it is critical to obtain the lowest input bias current, the PCB's surface leakage should be considered. Dry environment surface current increases further when the board is exposed to humidity, dust or chemical contamination. For harsh environment conditions, protecting the entire board surface (with all the exposed metal pins and soldered areas) is advised. Conformal coating or potting the board in resin proves effective in most cases.

An alternate solution for reduced leakage is the use of guard rings around sensitive pins and pads. A proper guard ring should have low impedance and be biased to the same voltage as the sensitive pin so that no current flows in between them.

For an inverting amplifier, the non-inverting input is usually connected to supply's ground (or virtual ground at half the rail voltage in single supply applications) so it can represent a good ring solution. When routing the PCB traces, create a closed perimeter around the inverting input pad (which carries the signal) and connect it to the non-inverting input.

For a non-inverting amplifier, use a similarly shaped (rectangle or circle) copper trace around the non-inverting input pad (which carries the signal) and connect it to the inverting input pin, which presents a much lower impedance thanks to the feedback network.

PCB Routing Recommendations

In addition to amplifying the useful signal, op amps can also pick the high frequency noise together with the signal and amplify it accordingly, if the design allows it. In order to reach the values specified in the Electrical Characteristics tables and to avoid high frequency interference issues, it is recommended that the PCB layout follows the basic guidelines listed below:

- ◆ A dedicated layer for the ground plane should be used whenever possible and all supply decoupling capacitors should connect to it by vias
- ◆ Copper traces should be as short as possible
- ◆ High current paths should not be shared by small signal or low current traces
- ◆ If present, switching power supply blocks should be kept away from the analog sensitive areas to avoid potential conducted and radiated noise issues
- ◆ When different circuit taxonomies share the same board, it is recommended to keep separated the power areas, the digital areas and the small signal analog areas. Small-signal components in the signal path should be placed as close as possible to the amplifier input pins
- ◆ Metal shielding the sensitive areas and the “offender” blocks may be required in some cases

PACKAGE DIMENSIONS

SC-88A (SC-70-5/SOT-353)
CASE 419A-02
ISSUE M

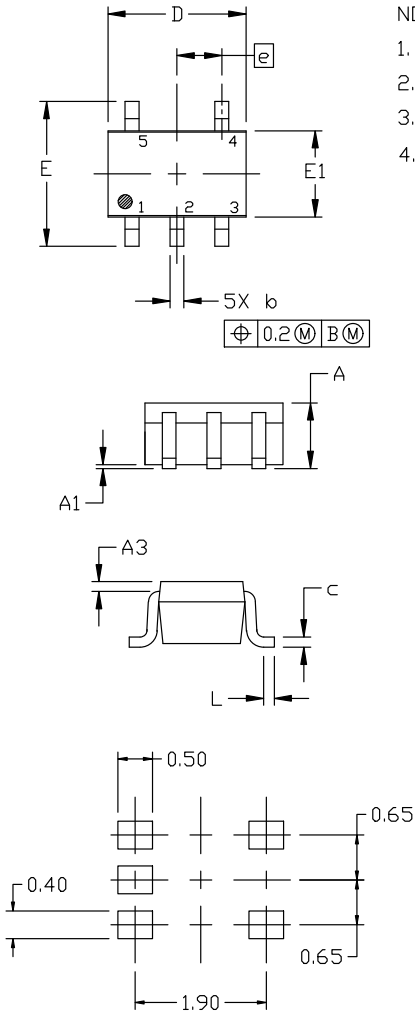

NOTES:

1. DIMENSIONING AND TOLERANCING PER ANSI Y14.5M, 1982.
2. CONTROLLING DIMENSION: MILLIMETERS
3. 419A-01 OBSOLETE. NEW STANDARD 419A-02
4. DIMENSIONS D AND E1 DO NOT INCLUDE MOLD FLASH, PROTRUSIONS, OR GATE BURRS. MOLD FLASH, PROTRUSIONS, OR GATE BURRS SHALL NOT EXCEED 0.1016MM PER SIDE.

| DIM | MILLIMETERS | | |
|-----|-------------|------|------|
| | MIN. | NOM. | MAX. |
| A | 0.80 | 0.95 | 1.10 |
| A1 | --- | --- | 0.10 |
| A3 | 0.20 REF | | |
| b | 0.10 | 0.20 | 0.30 |
| c | 0.10 | --- | 0.25 |
| D | 1.80 | 2.00 | 2.20 |
| E | 2.00 | 2.10 | 2.20 |
| E1 | 1.15 | 1.25 | 1.35 |
| e | 0.65 BSC | | |
| L | 0.10 | 0.15 | 0.30 |

RECOMMENDED MOUNTING FOOTPRINT

* For additional information on our Pb-Free strategy and soldering details, please download the ON Semiconductor Soldering and Mounting Techniques Reference Manual, SOLDERRM/D.

PACKAGE DIMENSIONS

SOIC-8 NB
CASE 751-07
ISSUE AK

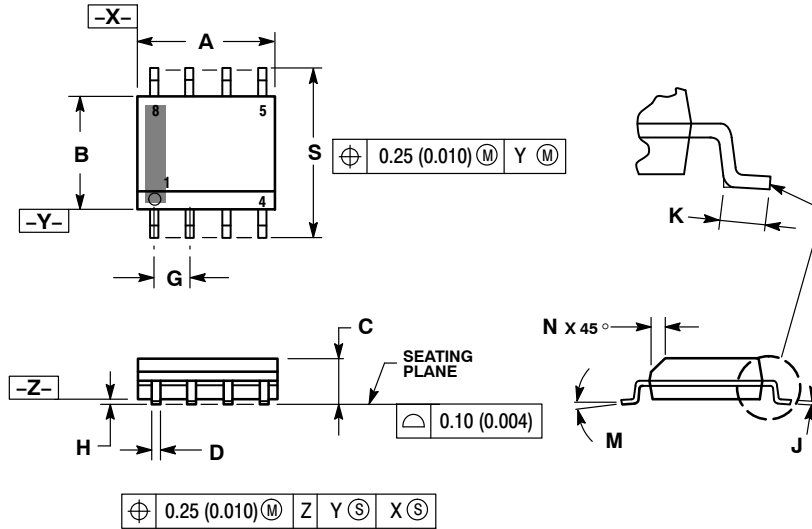

- NOTES:
1. DIMENSIONING AND TOLERANCING PER ANSI Y14.5M, 1982.
 2. CONTROLLING DIMENSION: MILLIMETER.
 3. DIMENSION A AND B DO NOT INCLUDE MOLD PROTRUSION.
 4. MAXIMUM MOLD PROTRUSION 0.15 (0.006) PER SIDE.
 5. DIMENSION D DOES NOT INCLUDE DAMBAR PROTRUSION. ALLOWABLE DAMBAR PROTRUSION SHALL BE 0.127 (0.005) TOTAL IN EXCESS OF THE D DIMENSION AT MAXIMUM MATERIAL CONDITION.
 6. 751-01 THRU 751-06 ARE OBSOLETE. NEW STANDARD IS 751-07.

| DIM | MILLIMETERS | | INCHES | |
|-----|-------------|------|-----------|-------|
| | MIN | MAX | MIN | MAX |
| A | 4.80 | 5.00 | 0.189 | 0.197 |
| B | 3.80 | 4.00 | 0.150 | 0.157 |
| C | 1.35 | 1.75 | 0.053 | 0.069 |
| D | 0.33 | 0.51 | 0.013 | 0.020 |
| G | 1.27 BSC | | 0.050 BSC | |
| H | 0.10 | 0.25 | 0.004 | 0.010 |
| J | 0.19 | 0.25 | 0.007 | 0.010 |
| K | 0.40 | 1.27 | 0.016 | 0.050 |
| M | 0 ° | 8 ° | 0 ° | 8 ° |
| N | 0.25 | 0.50 | 0.010 | 0.020 |
| S | 5.80 | 6.20 | 0.228 | 0.244 |

- STYLE 11:
- PIN 1. SOURCE 1
2. GATE 1
3. SOURCE 2
4. GATE 2
5. DRAIN 2
6. DRAIN 2
7. DRAIN 1
8. DRAIN 1

SOLDERING FOOTPRINT*

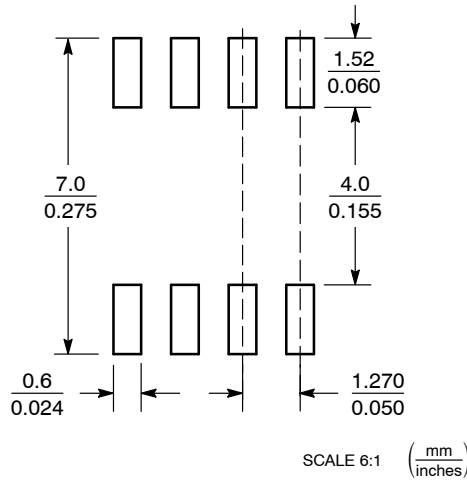

*For additional information on our Pb-Free strategy and soldering details, please download the **onsemi** Soldering and Mounting Techniques Reference Manual, SOLDERRM/D.

PACKAGE DIMENSIONS

TSOP-5
CASE 483
ISSUE N

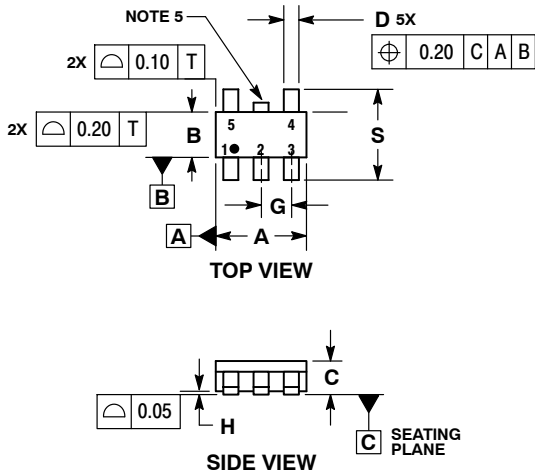

NOTES:

1. DIMENSIONING AND TOLERANCING PER ASME Y14.5M, 1994.
2. CONTROLLING DIMENSION: MILLIMETERS.
3. MAXIMUM LEAD THICKNESS INCLUDES LEAD FINISH THICKNESS. MINIMUM LEAD THICKNESS IS THE MINIMUM THICKNESS OF BASE MATERIAL.
4. DIMENSIONS A AND B DO NOT INCLUDE MOLD FLASH, PROTRUSIONS, OR GATE BURRS. MOLD FLASH, PROTRUSIONS, OR GATE BURRS SHALL NOT EXCEED 0.15 PER SIDE. DIMENSION A.
5. OPTIONAL CONSTRUCTION: AN ADDITIONAL TRIMMED LEAD IS ALLOWED IN THIS LOCATION. TRIMMED LEAD NOT TO EXTEND MORE THAN 0.2 FROM BODY.

| DIM | MILLIMETERS | |
|-----|-------------|------|
| | MIN | MAX |
| A | 2.85 | 3.15 |
| B | 1.35 | 1.65 |
| C | 0.90 | 1.10 |
| D | 0.25 | 0.50 |
| G | 0.95 BSC | |
| H | 0.01 | 0.10 |
| J | 0.10 | 0.26 |
| K | 0.20 | 0.60 |
| M | 0° | 10° |
| S | 2.50 | 3.00 |

SOLDERING FOOTPRINT*

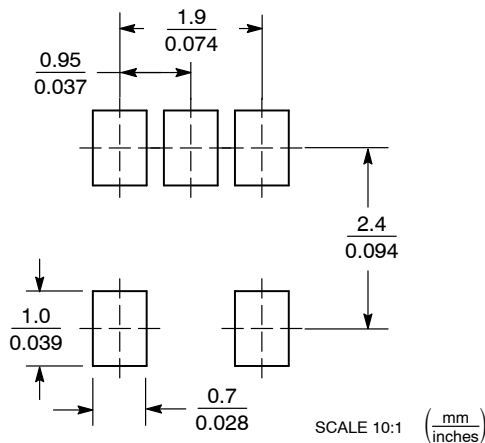

*For additional information on our Pb-Free strategy and soldering details, please download the **onsemi** Soldering and Mounting Techniques Reference Manual, SOLDERRM/D.

PACKAGE DIMENSIONS

Micro8
CASE 846A-02
ISSUE K

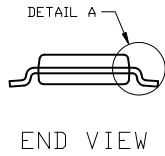
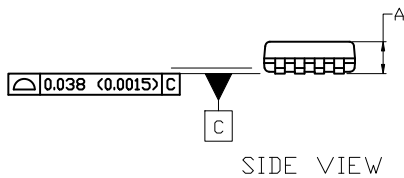
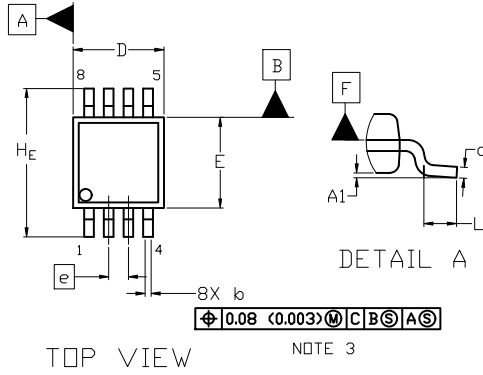

NOTES:

1. DIMENSIONING AND TOLERANCING PER ASME Y14.5M, 2009.
2. CONTROLLING DIMENSION: MILLIMETERS
3. DIMENSION b DOES NOT INCLUDE DAMBAR PROTRUSION. ALLOWABLE PROTRUSION SHALL BE 0.10 mm IN EXCESS OF MAXIMUM MATERIAL CONDITION.
4. DIMENSIONS D AND E DO NOT INCLUDE MOLD FLASH, PROTRUSION OR GATE BURRS. MOLD FLASH, PROTRUSIONS, OR GATE BURRS SHALL NOT EXCEED 0.15 mm PER SIDE. DIMENSION E DOES NOT INCLUDE INTERLEAD FLASH OR PROTRUSION. INTERLEAD FLASH OR PROTRUSION SHALL NOT EXCEED 0.25 mm PER SIDE. DIMENSIONS D AND E ARE DETERMINED AT DATUM F.
5. DATUMS A AND B ARE TO BE DETERMINED AT DATUM F.
6. A1 IS DEFINED AS THE VERTICAL DISTANCE FROM THE SEATING PLANE TO THE LOWEST POINT ON THE PACKAGE BODY.

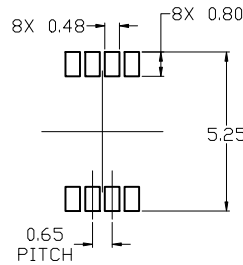

| DIM | MILLIMETERS | | |
|-----|-------------|------|------|
| | MIN. | NOM. | MAX. |
| A | --- | --- | 1.10 |
| A1 | 0.05 | 0.08 | 0.15 |
| b | 0.25 | 0.33 | 0.40 |
| c | 0.13 | 0.18 | 0.23 |
| D | 2.90 | 3.00 | 3.10 |
| E | 2.90 | 3.00 | 3.10 |
| e | 0.65 BSC | | |
| HE | 4.75 | 4.90 | 5.05 |
| L | 0.40 | 0.55 | 0.70 |

*For additional information on our Pb-Free strategy and soldering details, please download the **onsemi** Soldering and Mounting Techniques Reference Manual, SOLDERRM/D.

PACKAGE DIMENSIONS

TSSOP-14 WB
CASE 948G
ISSUE C

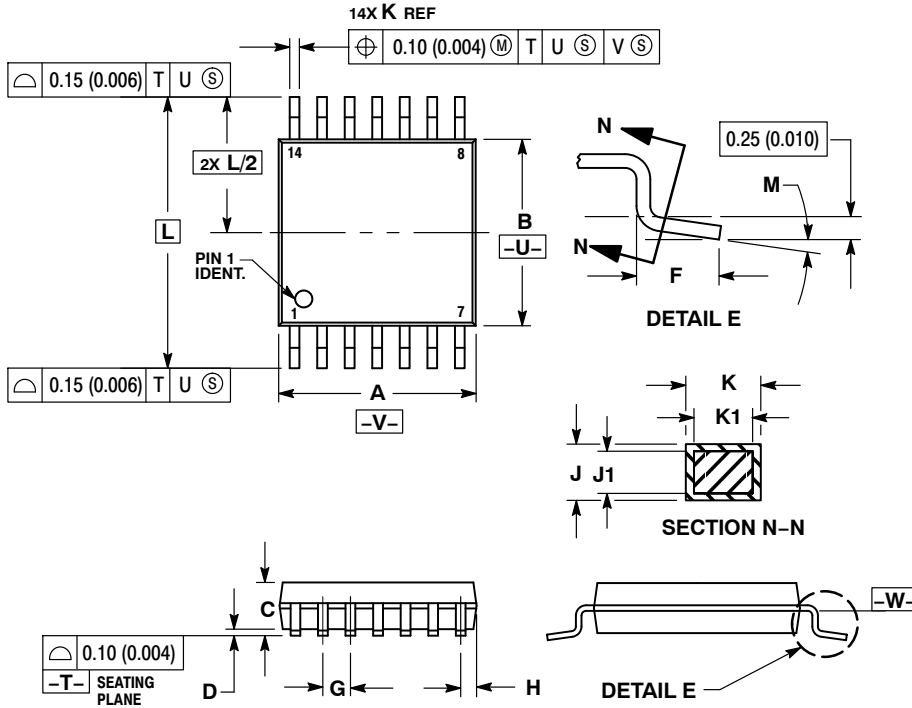

- NOTES:
1. DIMENSIONING AND TOLERANCING PER ANSI Y14.5M, 1982.
 2. CONTROLLING DIMENSION: MILLIMETER.
 3. DIMENSION A DOES NOT INCLUDE MOLD FLASH, PROTRUSIONS OR GATE BURRS. MOLD FLASH OR GATE BURRS SHALL NOT EXCEED 0.15 (0.006) PER SIDE.
 4. DIMENSION B DOES NOT INCLUDE INTERLEAD FLASH OR PROTRUSION. INTERLEAD FLASH OR PROTRUSION SHALL NOT EXCEED 0.25 (0.010) PER SIDE.
 5. DIMENSION K DOES NOT INCLUDE DAMBAR PROTRUSION. ALLOWABLE DAMBAR PROTRUSION SHALL BE 0.08 (0.003) TOTAL IN EXCESS OF THE K DIMENSION AT MAXIMUM MATERIAL CONDITION.
 6. TERMINAL NUMBERS ARE SHOWN FOR REFERENCE ONLY.
 7. DIMENSION A AND B ARE TO BE DETERMINED AT DATUM PLANE -V-.

| DIM | MILLIMETERS | | INCHES | |
|-----|-------------|------|-----------|-------|
| | MIN | MAX | MIN | MAX |
| A | 4.90 | 5.10 | 0.193 | 0.200 |
| B | 4.30 | 4.50 | 0.169 | 0.177 |
| C | --- | 1.20 | --- | 0.047 |
| D | 0.05 | 0.15 | 0.002 | 0.006 |
| F | 0.50 | 0.75 | 0.020 | 0.030 |
| G | 0.65 BSC | | 0.026 BSC | |
| H | 0.50 | 0.60 | 0.020 | 0.024 |
| J | 0.09 | 0.20 | 0.004 | 0.008 |
| J1 | 0.09 | 0.16 | 0.004 | 0.006 |
| K | 0.19 | 0.30 | 0.007 | 0.012 |
| K1 | 0.19 | 0.25 | 0.007 | 0.010 |
| L | 6.40 BSC | | 0.252 BSC | |
| M | 0° 8° | | 0° 8° | |

GENERIC MARKING DIAGRAM*

SOLDERING FOOTPRINT

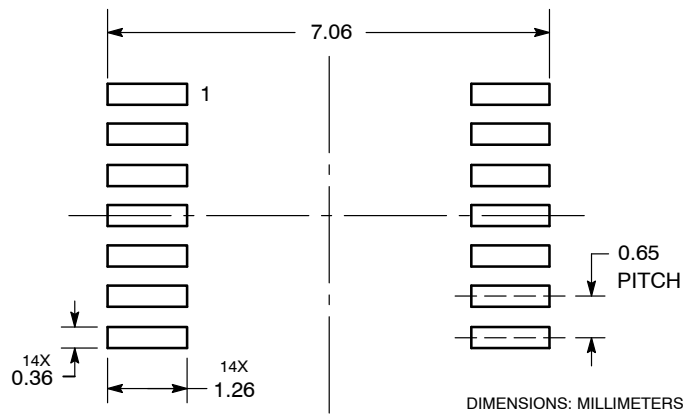

NCS20161, NCS20162, NCS20164, NCV20161, NCV20162, NCV20164

PACKAGE DIMENSIONS

SOIC-14 NB CASE 751A-03 ISSUE L

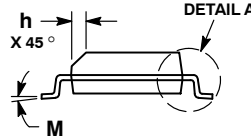
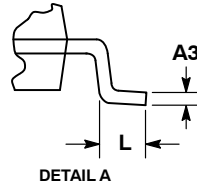
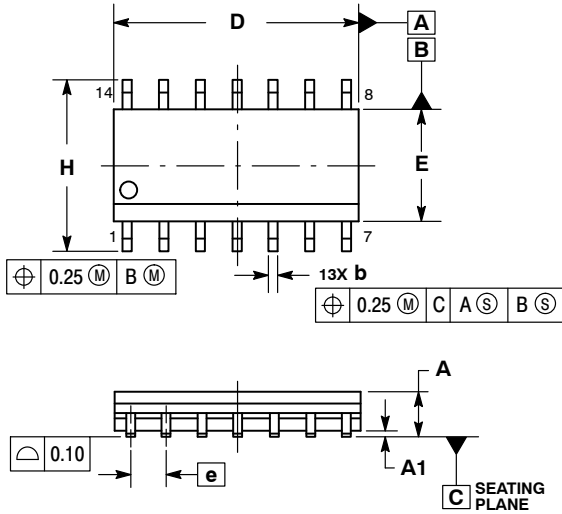

NOTES:

1. DIMENSIONING AND TOLERANCING PER ASME Y14.5M, 1994.
2. CONTROLLING DIMENSION: MILLIMETERS.
3. DIMENSION b DOES NOT INCLUDE DAMBAR PROTRUSION. ALLOWABLE PROTRUSION SHALL BE 0.13 TOTAL IN EXCESS OF AT MAXIMUM MATERIAL CONDITION.
4. DIMENSIONS D AND E DO NOT INCLUDE MOLD PROTRUSIONS.
5. MAXIMUM MOLD PROTRUSION 0.15 PER SIDE.

| DIM | MILLIMETERS | | INCHES | |
|-----|-------------|------|-----------|-------|
| | MIN | MAX | MIN | MAX |
| A | 1.35 | 1.75 | 0.054 | 0.068 |
| A1 | 0.10 | 0.25 | 0.004 | 0.010 |
| A3 | 0.19 | 0.25 | 0.008 | 0.010 |
| b | 0.35 | 0.49 | 0.014 | 0.019 |
| D | 8.55 | 8.75 | 0.337 | 0.344 |
| E | 3.80 | 4.00 | 0.150 | 0.157 |
| e | 1.27 BSC | | 0.050 BSC | |
| H | 5.80 | 6.20 | 0.228 | 0.244 |
| h | 0.25 | 0.50 | 0.010 | 0.019 |
| L | 0.40 | 1.25 | 0.016 | 0.049 |
| M | 0° | | 7° | |

SOLDERING FOOTPRINT*

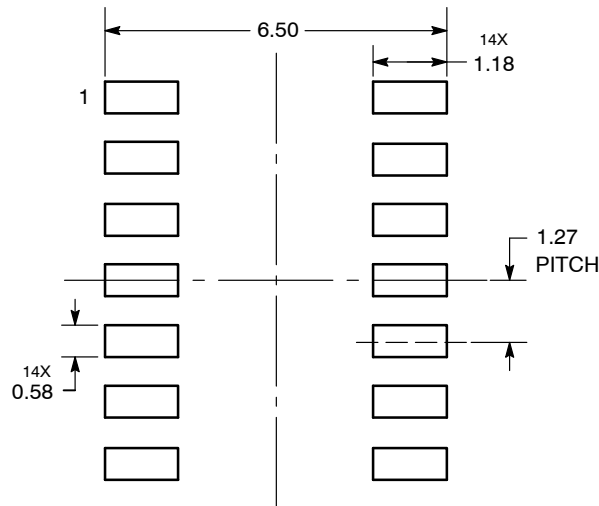

DIMENSIONS: MILLIMETERS

*For additional information on our Pb-Free strategy and soldering details, please download the **onsemi** Soldering and Mounting Techniques Reference Manual, SOLDERRM/D.

onsemi, **Onsemi**, and other names, marks, and brands are registered and/or common law trademarks of Semiconductor Components Industries, LLC dba "**onsemi**" or its affiliates and/or subsidiaries in the United States and/or other countries. **onsemi** owns the rights to a number of patents, trademarks, copyrights, trade secrets, and other intellectual property. A listing of **onsemi**'s product/patent coverage may be accessed at www.onsemi.com/site/pdf/Patent-Marking.pdf. **onsemi** reserves the right to make changes at any time to any products or information herein, without notice. The information herein is provided "as-is" and **onsemi** makes no warranty, representation or guarantee regarding the accuracy of the information, product features, availability, functionality, or suitability of its products for any particular purpose, nor does **onsemi** assume any liability arising out of the application or use of any product or circuit, and specifically disclaims any and all liability, including without limitation special, consequential or incidental damages. Buyer is responsible for its products and applications using **onsemi** products, including compliance with all laws, regulations and safety requirements or standards, regardless of any support or applications information provided by **onsemi**. "Typical" parameters which may be provided in **onsemi** data sheets and/or specifications can and do vary in different applications and actual performance may vary over time. All operating parameters, including "Typicals" must be validated for each customer application by customer's technical experts. **onsemi** does not convey any license under any of its intellectual property rights nor the rights of others. **onsemi** products are not designed, intended, or authorized for use as a critical component in life support systems or any FDA Class 3 medical devices or medical devices with a same or similar classification in a foreign jurisdiction or any devices intended for implantation in the human body. Should Buyer purchase or use **onsemi** products for any such unintended or unauthorized application, Buyer shall indemnify and hold **onsemi** and its officers, employees, subsidiaries, affiliates, and distributors harmless against all claims, costs, damages, and expenses, and reasonable attorney fees arising out of, directly or indirectly, any claim of personal injury or death associated with such unintended or unauthorized use, even if such claim alleges that **onsemi** was negligent regarding the design or manufacture of the part. **onsemi** is an Equal Opportunity/Affirmative Action Employer. This literature is subject to all applicable copyright laws and is not for resale in any manner.

PUBLICATION ORDERING INFORMATION

LITERATURE FULFILLMENT:
Email Requests to: orderlit@onsemi.com

onsemi Website: www.onsemi.com

TECHNICAL SUPPORT
North American Technical Support:
Voice Mail: 1 800-282-9855 Toll Free USA/Canada
Phone: 011 421 33 790 2910

Europe, Middle East and Africa Technical Support:
Phone: 00421 33 790 2910
For additional information, please contact your local Sales Representative